

EC-97912-05

CONTENTS

SECTION A2...CUSTOM ENTRANCES AND HARDWARE*

	PAGE
PRICING EXAMPLES	A2/3 – A2/4
190/350/500 BASE DOOR	
DOOR CHASSIS	A2/5
DOOR GLAZING/WEATHERING OPTIONS	A2/6
DOOR BOTTOM RAIL SUBSTITUTIONS	A2/7 – A2/8
DOOR CROSS RAIL/MUNTIN ADDITIONS	A2/9 – A2/10
STANDARD HINGING HARDWARE	
OFFSET PIVOTS/BUTT HINGES	A2/11 – 12
CONTINUOUS GEARED HINGE/CENTER PIVOT	A2/12
LOCKING HARDWARE	
STANDARD LOCKS	A2/13
MULTI-POINT LOCK ADDITIONS	A2/14
ACCESSORIES FOR STANDARD LOCKS	A2/15
EXIT DEVICE HARDWARE	
CONCEALED EXIT DEVICES AND ACCESSORIES	A2/16 – A2/17
RIM EXIT DEVICES AND ACCESSORIES	A2/18 – A2/19
KAWNEER PANELINE®/PANIC GUARD® & ACCESSORIES	A2/20
AUTO SHOWROOM ENTRANCES	
AUTO SHOWROOM ACCESSORIES, STANDARD AUTO SHOWROOM SPECIFICATIONS	A2/22
STANDARD PUSH/PULLS	
ARCHITECTS CLASSIC PUSH/PULL SETS	A2/23
PANIC PULLS/AUTO SHOWROOM PUSH BAR	A2/24
SPECIAL FABRICATED FRAMES	
TRIFAB® 400 FRAMING SYSTEM (1¾" X 4")	A2/25
TRIFAB® VG 450 FRAMING SYSTEM (1¾" X 4½" CENTER)	A2/26
TRIFAB® VG 451 FRAMING SYSTEM (2" X 4½" CENTER)	A2/27
TRIFAB® VG 451T FRAMING SYSTEM (2" X 4½" CENTER)	A2/28
ENCORE® DOOR FRAMES (1¾" X 4½") AND (1¾" X 6")	A2/29
1600 WALL SYSTEM® DOOR FRAME ADAPTORS	A2/29

*Continued on next page****NOTE: FOR HARDWARE NOT LISTED IN THE PRICE CATALOG, CONSULT ESTIMATING!**

Laws and building and safety codes governing the design and use of glazed entrance, window, and curtain wall products vary widely. Kawneer does not control the selection of product configurations, operating hardware, or glazing materials, and assumes no responsibility therefor.

Kawneer reserves the right to change configuration without prior notice when deemed necessary for product improvement.

© Kawneer Company, Inc., 2009

	PAGE
TRANSOM BAR/DOOR HEADER & THRESHOLD PACKAGES	
CENTER HUNG TRANSOM/HEADER & THRESHOLD PACKAGES	A2/30
S/A OFFSET ARM TRANSOM/HEADER & THRESHOLD PACKAGES.....	A2/31
HARDWARE BY OTHERS*	
HINGING HARDWARE	A2/32
PIVOTING HARDWARE	A2/33
LOCKING HARDWARE	A2/34
EXIT DEVICE HARDWARE	A2/38
CLOSERS AND DOOR HOLDERS	A2/40
MISCELLANEOUS HARDWARE	A2/41
HARDWARE OPTIONS	
ACCESS CONTROL – EXIT DEVICES WITH ELECTRIC LATCH	A2/43 – A2/47

GROUP NO. DESIGNATION	FINISHES INCLUDED
#17 GRP	#17 CLEAR
#40 GRP	#40 BRONZE BW – BONE WHITE #22 STD. PAINT #14 CLEAR
#29 GRP	#29 BLACK #18 CHAMPAGNE #26 LIGHT BRONZE #28 MEDIUM BRONZE

*NOTE: FOR HARDWARE NOT LISTED IN THE PRICE CATALOG, CONSULT ESTIMATING!

Laws and building and safety codes governing the design and use of glazed entrance, window, and curtain wall products vary widely. Kawneer does not control the selection of product configurations, operating hardware, or glazing materials, and assumes no responsibility therefor.

Kawneer reserves the right to change configuration without prior notice when deemed necessary for product improvement.
© Kawneer Company, Inc., 2009

EC-97912-05

PRICING EXAMPLES

PRICING EXAMPLE #1

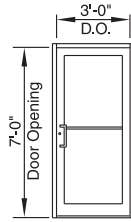

- #40 DARK BRONZE FINISH
- 350 SINGLE DOOR
- TRIFAB® VG 450 FRAME (CENTER)
- OFFSET PIVOTS
- MS LOCK – 2 CYLINDERS
- STANDARD THRESHOLD
- NORTON 1605BC W/H.O.
- CO-9 S/A PUSH/PULL SET
- ¼" BEVELED GLASS STOP

QTY.	PART NO.	DESCRIPTION	LIST PRICE	EXTENDED	PAGE
1	350SBVBK	350 CHASSIS	\$804.00	\$804.00	A2/5
1	138410	TOP OFFSET PIVOT	24.00	24.00	A2/11
1	138411	TOP OFFSET PIVOT PREP	15.00	15.00	A2/11
1	138412	BOTTOM OFFSET PIVOT	26.00	26.00	A2/11
1	138413	BOTTOM OFFSET PIVOT PREP	15.00	15.00	A2/11
1	137700P	CO-9 S/A PUSH/PULL SET	173.00	173.00	A2/23
1	138101	MS LOCK	41.00	41.00	A2/13
1	138102	MS LOCK PREP	25.00	25.00	A2/13
1	138671	(2) CYLINDERS (KEYED IN PAIRS)	18.00	18.00	A2/15
1	050879	NORTON 1601BC CLOSER	179.00	179.00	A3/2
3	4509121	T-BAR/HEADER (PER FT.)	23.42	70.26	A2/26
15	4509120	DOOR JAMB (PER FT.)	17.16	257.40	A2/26
3	4509145	THRESHOLD (PER FT.)	4.36	13.08	A2/26

TOTAL PRICE =

\$1,6660.74

PRICING EXAMPLE #2

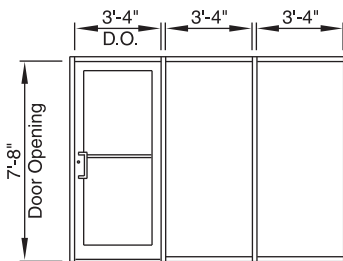

- #40 DARK BRONZE FINISH
- 350 SINGLE DOOR
- TRIFAB® VG 450 FRAME (CENTER)
- BUTT HINGES – #29 BLACK FINISH
- MS LOCK – 2 CYLINDERS
- STANDARD THRESHOLD
- NORTON 1605BC W/H.O.
- CO-12 S/A PUSH/PULL SET
- ¼" SQUARE GLASS STOP

QTY.	PART NO.	DESCRIPTION	LIST PRICE	EXTENDED	PAGE
1	350SBVBK	350 CHASSIS	\$804.00	\$804.00	A2/5
1	138234	SPECIAL WIDTH CHARGE	152.00	152.00	A2/5
1	138214	SQUARE GLASS STOP SUB	0.00	0.00	A2/6
3	138417	BUTT HINGES	56.00	168.00	A2/11
3	138418	BUTT HINGE PREPS	36.00	108.00	A2/11
1	137708P	CO-12 S/A PUSH/PULL SET	328.00	328.00	A2/23
1	138101	MS LOCK	41.00	41.00	A2/13
1	138102	MS LOCK PREP	25.00	25.00	A2/13
1	138671	(2) CYLINDERS (KEYED IN PAIRS)	18.00	18.00	A2/15
1	050879	NORTON 1601BC CLOSER	179.00	179.00	A3/2
4	4509121	T-BAR/HEADER (PER FT.)	23.42	93.68	A2/26
16	4509120	DOOR JAMB (PER FT.)	17.16	274.56	A2/26
4	4509145	THRESHOLD (PER FT.)	4.36	17.44	A2/26
8	4509117	MULLION (PER FT.)	16.60	132.80	A2/26
7	4509112	HEAD (PER FT.)	17.44	122.08	A2/26
15	4509114	SILL/JAMB (PER FT.)	16.27	244.05	A2/26

TOTAL PRICE =

\$2,707.61

PRICING EXAMPLE #3

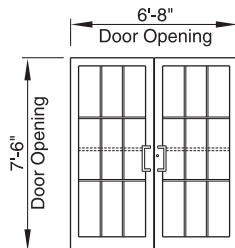

- #40 DARK BRONZE FINISH
- 350 PAIR OF DOORS
- CONTINUOUS HINGE
- MS LOCK – 2 CYLINDERS
- CO-9 S/A PUSH/PULL SET
- NORTON 1605BC W/H.O.
- ¼" SQUARE GLASS STOP
- 3 X 3 MUNTIN GRID USING 5/16" MUNTINS

QTY.	PART NO.	DESCRIPTION	LIST PRICE	EXTENDED	PAGE
1	350PBRBK	350 CHASSIS	\$1,608.00	\$1,608.00	A2/5
2	138234	SPECIAL WIDTH CHARGE	152.00	304.00	A2/5
38	138710	5/16" MUNTIN	8.00	304.00	A2/9
16	138716	CROSS RAIL / MUNTIN SET UP CHARGES	145.00	2,320.00	A2/10
2	138421	CONTINUOUS HINGE UP TO 8'0"	464.00	928.00	A2/11
2	137702P	CO-9 S/A PUSH/PULL SET	313.00	626.00	A2/23
1	138103	MS LOCK	50.00	50.00	A2/13
2	050879	NORTON 1601BC CLOSER	179.00	358.00	A3/2
1	138671	(2) CYLINDERS (KEYED IN PAIRS)	18.00	18.00	A2/15
1	138134	FLUSH BOLTS	50.00	50.00	A2/13

TOTAL PRICE =

\$6,566.00

PRICING EXAMPLE #4

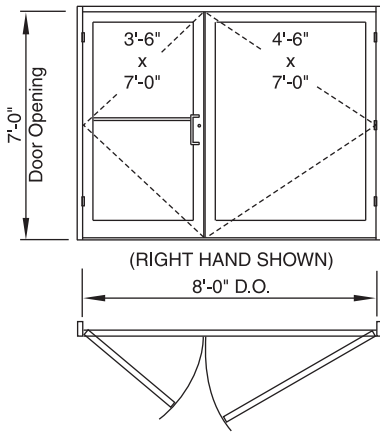

- AUTO SHOWROOM SWING TYPE
- #40 DARK BRONZE FINISH
- TRIFAB VG 450 (CENTER)
- BUTT HINGES – #29 BLACK FINISH

QTY.	PART NO.	DESCRIPTION	LIST PRICE	EXTENDED	PAGE
Active Leaf					
1	190SBVBK	190 CHASSIS	\$504.00	\$504.00	A2/5
1	138234	SPECIAL WIDTH CHARGE	152.00	152.00	A2/5
2	138417	BUTT HINGES	56.00	112.00	A2/11
2	138418	BUTT HINGE FRAME PREPS	36.00	72.00	A2/11
1	137701P	CO-9 S/A PUSH/PULL SET	188.00	188.00	A2/23
1	138103	MS LOCK	50.00	50.00	A2/13
1	138671	(2) CYLINDERS (KEYED IN PAIRS)	18.00	18.00	A2/15
1	050878	NORTON 1601 CLOSER	166.00	166.00	A3/2
Inactive Leaf					
1	190SBVBK	190 CHASSIS	504.00	504.00	A2/5
1	138234	SPECIAL WIDTH CHARGE	152.00	152.00	A2/5
1	138234	SPECIAL WIDTH CHARGE	152.00	152.00	A2/17
3	138417	BUTT HINGES	56.00	168.00	A2/11
3	138418	BUTT HINGE FRAME PREPS	36.00	108.00	A2/11
1	138134	PAIR OF FLUSH BOLTS	50.00	50.00	A2/13
1	138135	FLUSH BOLT FRAME PREP	30.00	30.00	A2/13
1	138729	RISER BLOCK	55.00	55.00	A2/22
Framing					
15	4509120	JAMB (PER FT.)	17.16	257.40	A2/26
8	4509121	T-BAR/HEADER (PER FT.)	23.42	187.36	A2/26
8	4509145	THRESHOLD (PER FT.)	4.36	34.88	A2/26

TOTAL PRICE = \$2,960.64

PRICING EXAMPLE #5

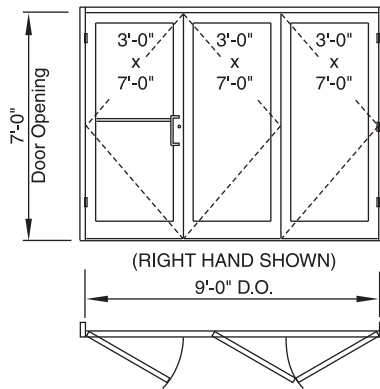

- AUTO SHOWROOM BI-FOLD TYPE
- BW – BONE WHITE PAINT DOORS/FRAMES
- #29 BLACK FINISH HARDWARE
- TRIFAB VG 450 (CENTER)

QTY.	PART NO.	DESCRIPTION	LIST PRICE	EXTENDED	PAGE
Active Leaf					
1	190SBVBK	190 CHASSIS	\$504.00	\$504.00	A2/5
2	138417	BUTT HINGES	56.00	112.00	A2/11
2	138418	BUTT HINGE FRAME PREPS	36.00	72.00	A2/11
1	137700P	CO-9 S/A PUSH/PULL SET	173.00	173.00	A2/23
1	138103	MS LOCK	54.00	54.00	A2/11
1	138671	(2) CYLINDERS (KEYED IN PAIRS)	18.00	18.00	A2/15
1	050878	NORTON 1601 CLOSER	166.00	166.00	A3/2
Inactive Leaf #1					
1	190SBVBK	190 CHASSIS	504.00	504.00	A2/5
1	138420	CONTINUOUS HINGE	462.00	462.00	A2/12
1	138134	PAIR OF FLUSH BOLTS	54.00	54.00	A2/13
1	138135	FLUSH BOLT FRAME PREP	30.00	30.00	A2/13
1	138729	RISER BLOCK	55.00	55.00	A2/22
Inactive Leaf #2					
1	190SBVBK	190 CHASSIS	504.00	504.00	A2/5
3	138417	BUTT HINGES	56.00	168.00	A2/11
3	138418	BUTT HINGE FRAME PREPS	36.00	108.00	A2/11
1	138134	PAIR OF FLUSH BOLTS	54.00	54.00	A2/13
1	138135	FLUSH BOLT FRAME PREP	30.00	30.00	A2/13
1	138729	RISER BLOCK	55.00	55.00	A2/22
Framing					
15	4509120	DOOR JAMB (PER FT.)	17.16	257.40	A2/26
9	4509121	T-BAR/HEADER (PER FT.)	23.42	210.78	A2/26
9	4509145	THRESHOLD (PER FT.)	4.36	39.24	A2/26

TOTAL PRICE = \$3,630.42

Laws and building and safety codes governing the design and use of glazed entrance, window, and curtain wall products vary widely. Kawneer does not control the selection of product configurations, operating hardware, or glazing materials, and assumes no responsibility therefor.

Kawneer reserves the right to change configuration without prior notice when deemed necessary for product improvement.
© Kawneer Company, Inc., 2009

EC-97912-05

DOOR CHASSIS

PRICE INCLUDES:



1. BLANK DOOR UP TO 3'0" X 8'0". (FOR DOORS EXCEEDING 4'0" X 8'0", CONSULT FACTORY.)
2. 1/4" BEVELED GLASS STOPS.
3. GLAZING GASKETS.

SPECIAL DOOR PRICING ADD THE FOLLOWING:

1. **BASE DOOR CHASSIS:** AS LISTED BELOW.
2. **HINGING HARDWARE:** SELECT THE DESIRED HINGING METHOD AND ADD THE PRICE OF THE HARDWARE.
3. **OPTIONS:** ADD THE PRICE OF ALL OTHER OPTIONS REQUIRED FOR DOOR AND/OR FRAME, BE SURE TO ADD HARDWARE AND PREPARATION CHARGES.

PART NUMBER STRUCTURE SAMPLE FOR BLANK DOORS

PRODUCT CODE	+	HANDING	+	PIVOTING	+	LOCKING
190 = 190 NARROW		S = SINGLE		BV = BEVELED STILE		BK = BLANK
350 = 350 MEDIUM		P = PAIR		BR = BEVELED RABBETED		
500 = 500 WIDE				RD = RADIUS		











DOOR CHASSIS	NARROW STILE 190		MEDIUM STILE 350		WIDE STILE 500			
	SINGLE	PAIR	SINGLE	PAIR	SINGLE	PAIR		
DOOR OPENING SIZE UP TO	3'0" X 8'0"	6'0" X 8'0"	3'0" X 8'0"	6'0" X 8'0"	3'0" X 8'0"	6'0" X 8'0"		
BEVELED STILES FOR OFFSET PIVOT OR BUTT HUNG DOORS		PART NO.	190SBVBK	190PBVBK	350SBVBK	350PBVBK	500SBVBK	500PBVBK
BEVEL RABBETED STILE FOR CONTINUOUS HINGE DOORS USE OF THIS STILE WILL NOT AFFECT GLASS SIZES		PART NO.	190SBRBK	190PBRBK	350SBRBK	350PBRBK	500SBRBK	500PBRBK
RADIUS STILES FOR CENTER HUNG DOORS		PART NO.	190SRDBK	190PRDBK	350SRDBK	350PRDBK	500SRDBK	500PRDBK
	#17 GRP	\$487.00	\$ 974.00	\$772.00	\$1,544.00	\$ 914.00	\$1,828.00	
	#40 GRP	504.00	1,008.00	804.00	1,608.00	954.00	1,908.00	
	#29 GRP	546.00	1,092.00	882.00	1,764.00	1,052.00	2,104.00	

SPECIAL WIDTH DOOR	PART NUMBER	PRICE
		138234

NOTE:



1. ALL PRICES ARE PER LEAF UNLESS NOTED OTHERWISE.

GLASS STOP OPTIONS

STANDARD STOPS	5/16" MUNTIN STOPS		PART NO.	#17 GRP	#40 GRP	#29 GRP
		1/4" SQUARE (FOR 1/4" & 3/16" GLASS)	138214	\$0.00	\$0.00	\$0.00
		3/8" SQUARE (FOR 3/16" & 3/8" GLASS)	138215	0.00	0.00	0.00
		1/2" SQUARE* (FOR 7/16" & 1/2" GLASS)	138216	0.00	0.00	0.00
		5/8" SQUARE* (FOR 3/16" & 5/8" GLASS)	138217	0.00	0.00	0.00
		3/4" SQUARE* (FOR 1 1/16" & 3/4" GLASS)	138218	0.00	0.00	0.00
		1" SQUARE* (FOR 1" GLASS)	138219	0.00	0.00	0.00

*RECOMMENDATION: ADD INTERMEDIATE HINGING AS STATED ON PIVOTING HARDWARE PAGES, A2/11.

DOOR BOTTOM WEATHERING

		PART NO.	#17 GRP	#40 GRP	#29 GRP
	FOR 3'0" DOOR	200795	\$16.00	\$18.00	\$20.00
	FOR 3'6" DOOR	200796	19.00	21.00	23.00
	VARIABLE TO 4'0"	200799	22.00	24.00	26.00
	FOR 6'0" PAIRS	200798	32.00	36.00	40.00
	3'0" LONG	037092	6.00	6.00	6.00
	4'0" LONG	037093	8.00	8.00	8.00

Laws and building and safety codes governing the design and use of glazed entrance, window, and curtain wall products vary widely. Kawneer does not control the selection of product configurations, operating hardware, or glazing materials, and assumes no responsibility therefor.





Kawneer reserves the right to change configuration without prior notice when deemed necessary for product improvement.
© Kawneer Company, Inc., 2009

EC-97912-05

DOOR BOTTOM RAIL SUBSTITUTIONS

NOTE:

1. ALL PRICES ARE PER LEAF UNLESS NOTED OTHERWISE.

			PART NO.	FABRICATED PRICE		
				#17 GRP	#40 GRP	#29 GRP
SUBSTITUTE BOTTOM RAILS						
	6½" BOTTOM RAIL	IN 190 DOOR	138724	\$ 35.00	\$ 35.00	\$35.00
	7½" BOTTOM RAIL	IN 190 DOOR	138725	38.00	38.00	38.00
		IN 350 OR 500 DOOR	138726	35.00	35.00	35.00
	10" BOTTOM RAIL	IN 190 DOOR	138727	75.00	75.00	75.00
		IN 350 OR 500 DOOR	138728	72.00	72.00	72.00
	12" BOTTOM RAIL	IN 190 DOOR	031212	221.00	237.00	—
		IN 350 OR 500 DOOR	031213	208.00	222.00	—

Laws and building and safety codes governing the design and use of glazed entrance, window, and curtain wall products vary widely. Kawneer does not control the selection of product configurations, operating hardware, or glazing materials, and assumes no responsibility therefor.

Kawneer reserves the right to change configuration without prior notice when deemed necessary for product improvement.



© Kawneer Company, Inc., 2009

DOOR BOTTOM RAIL SUBSTITUTIONS

EC-97912-05

NOTE:

1. ALL PRICES ARE PER LEAF UNLESS NOTED OTHERWISE.

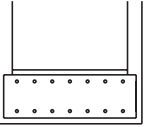
			FABRICATED PRICE			
			PART NO.	#17 GRP	#40 GRP	#29 GRP
KICK PLATES WITH BUILT UP BOTTOM RAIL						
	BOTTOM RAIL (ALUMINUM KICKPLATES – APPLIED, BOTH SIDES)	UP TO 10" HIGH	138721	\$530.00	\$560.00	\$625.00
		FOR EACH 3" ADDITIONAL	138722	160.00	168.00	188.00
	REINFORCEMENT RAIL (USE IF OVER 30" TALL)	INT. REINFORCING RAIL	138723	\$150.00 (NO FINISH)		
BUILT UP BOTTOM RAIL						
	BOTTOM RAIL	UP TO 10" HIGH	138200	570.00	605.00	680.00
		FOR EACH 3" ADDITIONAL	138208	170.00	180.00	200.00
	WEAR SHIELD (BLACK FINISH ONLY. APPLIED PUSH SIDE STD. DOUBLE PRICE FOR BOTH SIDES.)	UP TO 10" HIGH	138203	\$90.00 (NO FINISH)		
		FOR EACH 3" ADDITIONAL	138204	\$27.00 (NO FINISH)		
BOTTOM RAIL ADAPTORS						
	ADAPTORS (APPLIED)	7½" ON STD. 190 10½" ON STD. 350/500	138718	220.00	220.00	220.00
		10" ON STD. 190 12½" ON STD. 350/500	138719	231.00	231.00	231.00
		12" ON STD. 190 14½" ON STD. 350/500	138720	244.00	244.00	244.00
	SURFACE APPLIED ALUMINUM KICK PLATE (WITH EXPOSED FASTENERS)	UP TO 12" HIGH, ONE SIDE ONLY	031614	232.00	253.00	—
		FOR EACH 3" ADDITIONAL (OR PORTION THEREOF)	031615	26.00	30.00	—

Laws and building and safety codes governing the design and use of glazed entrance, window, and curtain wall products vary widely. Kawneer does not control the selection of product configurations, operating hardware, or glazing materials, and assumes no responsibility therefor.

Kawneer reserves the right to change configuration without prior notice when deemed necessary for product improvement.









© Kawneer Company, Inc., 2009

EC-97912-05

DOOR CROSS RAIL / MUNTIN ADDITIONS

NOTES:

1. ALL PRICES ARE **PER FOOT** UNLESS NOTED OTHERWISE.
2. ALL CROSS RAILS/MUNTINS INCLUDE ANY OF THE GLASS STOPS LISTED ON PAGE A2/6.
3. SET-UP CHARGES ARE REQUIRED WITH ALL CROSS RAILS/MUNTINS. ONE CHARGE PER CROSS RAIL/MUNTIN EITHER AS A HORIZONTAL OR VERTICAL.
4. **WHEN VERTICAL MUNTINS ARE REQUIRED TO CREATE A GRID CONFIGURATION, SQUARE GLASS STOPS ARE STANDARD.**

		PER FOOT PRICE			
		PART NO.	#17 GRP	#40 GRP	#29 GRP
CROSS RAILS					
	5/16" MUNTIN	138710	\$ 7.00	\$ 8.00	\$ 9.00
	7/8" CROSS RAIL	138711	11.00	12.00	13.00
	1 3/8" CROSS RAIL	138709	12.00	13.00	14.00
	2 1/4" CROSS RAIL	138712	13.00	14.00	16.00
	3 1/2" CROSS RAIL	138713	16.00	17.00	19.00
	6" CROSS RAIL	138714	20.00	22.00	25.00
	8 1/4" CROSS RAIL	138715	22.00	24.00	27.00
	10" CROSS RAIL	031215	55.00	60.00	—
	12" CROSS RAIL	031216	66.00	72.00	—

Laws and building and safety codes governing the design and use of glazed entrance, window, and curtain wall products vary widely. Kawneer does not control the selection of product configurations, operating hardware, or glazing materials, and assumes no responsibility therefor.

Kawneer reserves the right to change configuration without prior notice when deemed necessary for product improvement.

© Kawneer Company, Inc., 2009

NOTES:

1. ALL PRICES ARE **PER FOOT** UNLESS NOTED OTHERWISE.
2. ALL CROSS RAILS/MUNTINS INCLUDE ANY OF THE GLASS STOPS LISTED ON PAGE A2/6.
3. SET-UP CHARGES ARE REQUIRED WITH ALL CROSS RAILS/MUNTINS. ONE CHARGE PER CROSS RAIL/MUNTIN EITHER AS A HORIZONTAL OR VERTICAL.
4. **WHEN VERTICAL MUNTINS ARE REQUIRED TO CREATE A GRID CONFIGURATION, SQUARE GLASS STOPS ARE STANDARD.**

	PART NO.	PER FOOT PRICE		
		#17 GRP	#40 GRP	#29 GRP
BARRIER FREE OPTION  8 1/4" CROSS RAIL (ENGRAVED IN CROSS RAIL) PER LEAF CHARGE UP TO 48" WIDE	138205	\$295.00	\$350.00	—
CROSS RAIL/MUNTIN SET-UP CHARGE RAIL SET-UP CHARGE (SEE SAMPLE BELOW)	138716		\$145.00	
SUBSTITUTE BEVELED GLASS STOPS IN A GRID CONFIGURATION (CHARGE PER LITE OPENING)	138717		\$200.00	

SAMPLE OF CROSS RAIL/MUNTIN SET-UP CHARGE

THE GRID AT RIGHT HAS A TOTAL OF 8 RAIL SET-UP CHARGES.
 TWO (2) HORIZONTAL RAIL CHARGES & SIX (6) VERTICAL RAIL CHARGES.
 (HORIZONTAL RAILS ALWAYS RUN THROUGH.)

IF BEVELED STOPS ARE REQUIRED FOR THIS CONFIGURATION,
 ADD 9 EACH (138717) LITE CHARGES ABOVE.

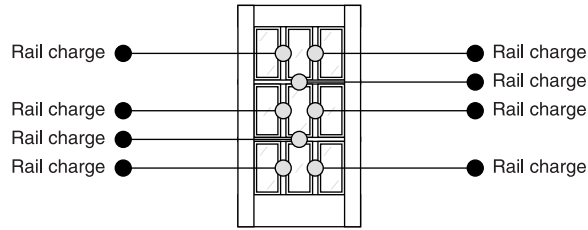

Laws and building and safety codes governing the design and use of glazed entrance, window, and curtain wall products vary widely. Kawneer does not control the selection of product configurations, operating hardware, or glazing materials, and assumes no responsibility therefor.





Kawneer reserves the right to change configuration without prior notice when deemed necessary for product improvement.
 © Kawneer Company, Inc., 2009

EC-97912-05

OFFSET PIVOTS / BUTT HINGES

NOTES:

1. REFER TO THE GENERAL INFORMATION SECTION FOR HARDWARE COLOR COMBINATIONS.
2. PRICES FOR HARDWARE LISTED ARE **PER ITEM**. I.E. SELECT (6) BUTT HINGES TO RECEIVE 1½ PAIRS OF BUTTS PER LEAF ON A PAIR OF DOORS.

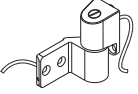
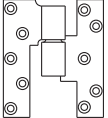
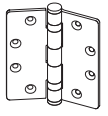
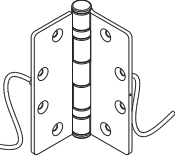
		FABRICATED PRICE					
		PART NO.	#17 GRP	#40 GRP	#29 GRP		
	TOP OFFSET PIVOT (KAWNEER STANDARD)	HARDWARE + DOOR PREP	138410	\$ 23.00	\$ 24.00	\$ 27.00	
		FRAME PREP	138411	\$15.00			
	BOTTOM OFFSET PIVOT (FOR USE WITH THRESHOLD)	HARDWARE + DOOR PREP	138412	25.00	26.00	30.00	
		FRAME PREP	138413	\$15.00			
	BOTTOM OFFSET PIVOT (FOR USE WITHOUT THRESHOLD)	HARDWARE + DOOR PREP	138414	25.00	25.00	25.00	
		FRAME PREP (N/A WITHOUT THRESHOLD)	—	—			
	BOTTOM OFFSET PIVOT THRESHOLD MOUNTED, FOR OPEN BACK FRAMES WITH 450053 & 450055 THRESHOLD	HARDWARE + DOOR PREP	031217	33.00	33.00	—	
						—	
	INTERMEDIATE OFFSET PIVOT (KAWNEER STANDARD)	HARDWARE + DOOR PREP	138210	168.00	176.00	198.00	
		FRAME PREP (INCLUDES REINFORCING)	138211	\$35.00			
	INTERMEDIATE ELECTRIC TRANSFER OFFSET PIVOT (KAWNEER STANDARD) (WIRING PREP NOT INCLUDED)	HARDWARE + DOOR PREP (INCLUDES HINGE & WIRING HARNESS)	138431 (R.H.) 138432 (L.H.)	582.00	590.00	600.00	
		FRAME PREP (INCLUDES REINFORCING)	138211	\$35.00			
	OPTIONAL INTERMEDIATE OFFSET PIVOT	HARDWARE + DOOR PREP	138415	332.00	350.00	392.00	
		FRAME PREP (INCLUDES REINFORCING)	138416	\$115.00			
	BUTT HINGES	4½" X 4" STANDARD W/N.R.P. (ROUNDED CORNER)	HARDWARE + DOOR PREP	138417	52.00	—	56.00
			FRAME PREP (INCLUDES REINFORCING)	138418	\$36.00		
		4½" X 4" 304 STAINLESS STEEL W/N.R.P. (ROUNDED CORNER)	HARDWARE + DOOR PREP	138408	57.00	—	61.00
			FRAME PREP (INCLUDES REINFORCING)	138418	\$36.00		
	4½" X 4" ELECTRIC TRANSFER (ROUNDED CORNER) (WIRING PREP NOT INCLUDED)	HARDWARE + DOOR PREP (INCLUDES HINGE & WIRING HARNESS)	138430	522.00	—	530.00	
		FRAME PREP (INCLUDES REINFORCING)	138418	\$36.00			

Laws and building and safety codes governing the design and use of glazed entrance, window, and curtain wall products vary widely. Kawneer does not control the selection of product configurations, operating hardware, or glazing materials, and assumes no responsibility therefor.

Kawneer reserves the right to change configuration without prior notice when deemed necessary for product improvement.





© Kawneer Company, Inc., 2009

RULE OF THUMB FOR ADDING INTERMEDIATE HINGES		
DR. HEIGHT	INFILL WEIGHT	RECOMMENDATIONS
ALL DOORS	GREATER THAN 5 LB. PER SQ. FT.	ADD ONE (1) HINGE
OVER 7'3"	GREATER THAN 5 LB. PER SQ. FT.	ADD TWO (2) HINGES
OVER 7'6"	LESS THAN 5 LB. PER SQ. FT.	ADD ONE (1) HINGE
OVER 8'3"	GREATER THAN 5 LB. PER SQ. FT.	ADD THREE (3) HINGES
OVER 8'6"	LESS THAN 5 LB. PER SQ. FT.	ADD TWO (2) HINGES

RULE OF THUMB FOR ADDING INTERMEDIATE PIVOTS		
DR. HEIGHT	INFILL WEIGHT	RECOMMENDATIONS
OVER 7'6"	ALL INFILLS	ADD ONE (1) PIVOT

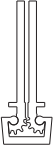
CONTINUOUS GEARED HINGE / CENTER PIVOTS

- NOTES:**
 1. REFER TO MISCELLANEOUS STOCK LENGTH SECTION C/10 FOR FINGER PROTECTORS FOR USE WITH CENTER HUNG DOORS.
 2. PRICES FOR HARDWARE LISTED ARE **PER ITEM**, I.E. SELECT (2) BOTTOM CENTER PIVOTS FOR A PAIR OF DOORS.

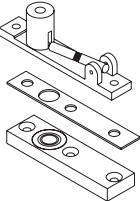
	PART NO.	FABRICATED PRICE		
		#17 GRP	#40 GRP	#29 GRP
CONTINUOUS GEARED HINGE				
				
UP TO 7'0"	HARDWARE + DOOR PREP	138420	\$334.00	\$462.00
UP TO 8'0"	HARDWARE + DOOR PREP	138421	377.00	535.00
	FRAME PREP	138429	\$50.00	
CENTER PIVOTS				
	BOTTOM CENTER PIVOT FOR USE WITH THRESHOLD (FOR C.O.C. OR CENTER HUNG FREE SWING DOORS)			
	HARDWARE + DOOR PREP	138423	\$ 25.00	
	FRAME PREP - TO THRESHOLD	138424	15.00	
	BOTTOM CENTER PIVOT FOR USE WITHOUT THRESHOLD (FOR C.O.C. OR CENTER HUNG FREE SWING DOORS)			
	HARDWARE + DOOR PREP	138425	\$ 28.00	
	FRAME PREP (N/A WITHOUT THRESHOLD)	—	—	
	TOP CENTER PIVOT KAWNEER WALKING BEAM PIVOT (FOR FLOOR CLOSER OR CENTER HUNG FREE SWING DOORS)			
	DOOR HARDWARE	138426	\$156.00	
	FRAME HARDWARE	138427	85.00	
	FRAME PREP	138428	140.00	
	TOP CENTER PIVOT L.C.N. WALKING BEAM PIVOT			
	DOOR PREP	031220	\$129.00	
	DOOR + FRAME HARDWARE	038601	259.00	

Laws and building and safety codes governing the design and use of glazed entrance, window, and curtain wall products vary widely. Kawneer does not control the selection of product configurations, operating hardware, or glazing materials, and assumes no responsibility therefor.

Kawneer reserves the right to change configuration without prior notice when deemed necessary for product improvement.
 © Kawneer Company, Inc., 2009

EC-97912-05

STANDARD LOCKS

NOTES:

1. LOCKING OPTIONS DO NOT INCLUDE THE CYLINDERS OR LOCK OPERATORS. SELECT CYLINDERS AND LOCK OPERATORS SEPARATELY.
2. BACKSET FOR ALL LOCKS LISTED ON THIS PAGE IS 1 1/8".
3. REFER TO THE GENERAL INFORMATION SECTION FOR HARDWARE COLOR COMBINATIONS.

LOCKING HARDWARE OPTIONS

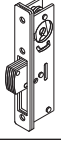
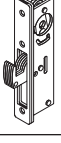
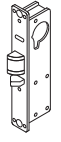
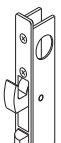
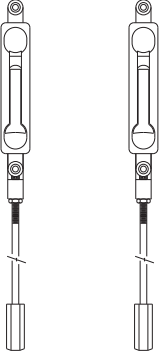
		PART NO.	FABRICATED PRICE			
			#17 GRP	#40 GRP	#29 GRP	
	STANDARD ADAMS RITE MS1850 LOCK					
	SINGLE	HARDWARE + DOOR PREP	138101	\$ 37.00	\$ 41.00	\$ 45.00
		FRAME PREP	138102		\$25.00	
	PAIR	HARDWARE + DOOR PREP	138103	46.00	50.00	54.00
		FRAME PREP	—			
	ADAMS RITE MS1850-020 SHORT THROW LOCK					
	SINGLE	HARDWARE + DOOR PREP	138104	50.00	53.00	57.00
		FRAME PREP	138102		\$25.00	
	PAIR	HARDWARE + DOOR PREP	138105	59.00	62.00	66.00
		FRAME PREP	—			
	ADAMS RITE MS1850-050 HOOKBOLT LOCK					
	SINGLE	HARDWARE + DOOR PREP	138106	50.00	53.00	57.00
		FRAME PREP	138107		\$25.00	
	PAIR	HARDWARE + DOOR PREP	138108	59.00	62.00	66.00
		FRAME PREP	—			
	ADAMS RITE 4510 LATCH LOCK					
	SINGLE	HARDWARE + DOOR PREP	138120	300.00	315.00	355.00
		OFFSET HUNG FRAME PREP	138121			
		CENTER HUNG FRAME PREP	138122			
	PAIR	HARDWARE + DOOR PREP	138123	315.00	332.00	375.00
		FRAME PREP	—			
	ADAMS RITE MS+1890 DEADBOLT LATCH LOCK					
	SINGLE	HARDWARE + DOOR PREP	138124	474.00	500.00	562.00
		OFFSET HUNG FRAME PREP	138125		\$75.00	
		CENTER HUNG FRAME PREP	138126			
	PAIR	HARDWARE + DOOR PREP	138127	477.00	503.00	565.00
		FRAME PREP	—			
	KAWNEER STANDARD FLUSH BOLTS* (FOR USE ON PAIRS OF DOORS WITH MS & LATCH LOCKS)					
	NOTE: 1. N/A WITH 3-POINT LOCK CONVERSION KIT, OR CONTROLLER THREE POINT LOCKING SYSTEM. PRICE INCLUDES (1) PAIR OF FLUSH BOLTS					
		HARDWARE + DOOR PREP	138134	46.00	50.00	54.00
		FRAME PREP	138135		\$30.00	
SHUTTERED/FLORIDA APPROVED FLUSH BOLTS* (FOR USE ON PAIRS OF DOORS WITH MS & 3-POINT DEAD LOCK)						
PRICE INCLUDES (1) PAIR OF FLUSH BOLTS.						
	HARDWARE + DOOR PREP	138128	50.00	54.00	58.00	
	FRAME PREP	138135		\$30.00		

*SOME BUILDING CODES, WITH SOME QUALIFICATIONS, PROHIBIT THE USE OF MANUAL FLUSH BOLTS ON EXIT DOORS NEEDED TO HANDLE THE OCCUPANT LOAD OF THE BUILDING. PLEASE CONSULT WITH YOUR LOCAL CODE TO VERIFY THE USE OF MANUAL FLUSH BOLTS FOR YOUR SPECIFIC APPLICATION.

Laws and building and safety codes governing the design and use of glazed entrance, window, and curtain wall products vary widely. Kawneer does not control the selection of product configurations, operating hardware, or glazing materials, and assumes no responsibility therefor.

Kawneer reserves the right to change configuration without prior notice when deemed necessary for product improvement.

© Kawneer Company, Inc., 2009

NOTES:

1. 3-POINT LOCKING OPTION DOES NOT INCLUDE THE MS LOCK, CYLINDERS OR LOCK OPERATORS. SELECT MS1850 LOCK, CYLINDERS AND LOCK OPERATORS SOLD SEPARATELY.
2. BACKSET FOR ALL LOCKS LISTED ON THIS PAGE IS 1 1/8."

MULTI-POINT LOCKING HARDWARE OPTIONS

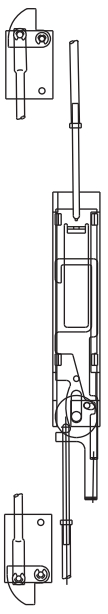
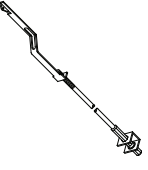
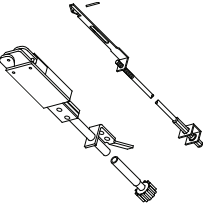
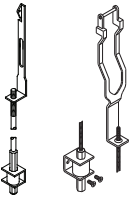
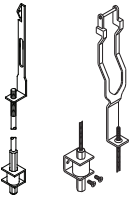
	PART NO.	FABRICATED PRICE		
		#17 GRP	#40 GRP	#29 GRP
 <p>CONTROLLER® (3-POINT LOCKING SYSTEM) FOR USE IN INACTIVE LEAF OF PAIRS OF DOORS ONLY SINGLE ACTING APPLICATIONS ONLY USE WITH ADAMS RITE MS1850 LOCK</p>	HARDWARE + DOOR PREP	138116	\$410.00	
	FRAME PREP	138117	30.00	
	<p>CONTROLLER® FE (3-POINT LOCKING SYSTEM) FOR USE IN INACTIVE LEAF OF PAIRS OF DOORS ONLY SINGLE ACTING APPLICATIONS ONLY USE WITH ADAMS RITE MS1850 LOCK CONTROLLER FE MEETS DADE COUNTY'S FORCED ENTRY RESISTANCE REQUIREMENT</p>			
 <p>ADAMS RITE 4015 TWO POINT LOCK (FOR USE ON SINGLES OR PAIRS OF DOORS) INCLUDES CONVERSION KIT FOR STD. MS1850 LOCK TO 2-PT. LOCK</p>	HARDWARE + DOOR PREP	138118	466.00	
	FRAME PREP	138117	30.00	
	<p>ADAMS RITE 4085 + THREE POINT LOCK (FOR USE ON PAIRS OF DOORS ONLY. N/A WITH FLUSH BOLTS) INCLUDES CONVERSION KIT FOR STD. MS1850 LOCK TO 3-PT. LOCK</p>			
	HARDWARE + DOOR PREP	138130	200.00	
	FRAME PREP (ONLY REQ'D. WITH THRESHOLD)	138131	30.00	
	<p>ADAMS RITE 4085 + THREE POINT LOCK (FOR USE ON PAIRS OF DOORS ONLY. N/A WITH FLUSH BOLTS) INCLUDES CONVERSION KIT FOR STD. MS1850 LOCK TO 3-PT. LOCK</p>			
 <p>SHUTTERED/FLORIDA APPROVED MS THREE POINT LOCK ADAMS RITE 4016 TOP BOLT & 4056 THRESHOLD BOLT WITH HURRICANE GUIDES (FOR USE ON PAIRS OF DOORS ONLY. N/A WITH FLUSH BOLTS) INCLUDES CONVERSION KIT FOR STD. MS1850 LOCK TO 3-PT. LOCK</p>	HARDWARE + DOOR PREP	138132	266.00	
	FRAME PREP	138133	30.00	
	<p>SHUTTERED/FLORIDA APPROVED MS THREE POINT LOCK ADAMS RITE 4016 TOP BOLT & 4056 THRESHOLD BOLT WITH HURRICANE GUIDES (FOR USE ON PAIRS OF DOORS ONLY. N/A WITH FLUSH BOLTS) INCLUDES CONVERSION KIT FOR STD. MS1850 LOCK TO 3-PT. LOCK</p>			
	HARDWARE + DOOR PREP	138109	292.00	
	FRAME PREP	138119	30.00	

Laws and building and safety codes governing the design and use of glazed entrance, window, and curtain wall products vary widely. Kawneer does not control the selection of product configurations, operating hardware, or glazing materials, and assumes no responsibility therefor.

Kawneer reserves the right to change configuration without prior notice when deemed necessary for product improvement.

© Kawneer Company, Inc., 2009







EC-97912-05

ACCESSORIES FOR STANDARD LOCKS

NOTES:

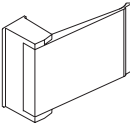
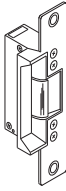
1. REFER TO THE GENERAL INFORMATION SECTION FOR HARDWARE COLOR COMBINATIONS.

ACCESSORIES FOR USE WITH LOCKING HARDWARE OPTIONS ON PAGES A2/13 & A2/14

		FABRICATED PRICE			
		PART NO.	#17 GRP	#40 GRP	#29 GRP
	ADAMS RITE 4560 LEVER HANDLE (FOR USE ON 4510 LATCH LOCKS ONLY) STANDARD 3½" HANDLE.				
	HARDWARE + DOOR PREP	138239	\$110.00	\$110.00	\$110.00
	ADAMS RITE 4565 EMERGENCY HANDLE (FOR USE ON 4510 OR MS-1890 LATCH LOCKS ONLY) OPTIONAL 1½" HANDLE.				
	HARDWARE + DOOR PREP	138240	110.00	110.00	110.00
	ADAMS RITE 4590 LATCH PADDLE (FOR USE ON 4510 OR MS1890 LATCH LOCKS ONLY) OPTIONAL PADDLE.				
	HARDWARE + DOOR PREP	138241	168.00	168.00	168.00
	ADAMS RITE 7130 ELECTRIC STRIKE (FOR USE ON 4510 LATCH LOCKS ONLY) WIRING & ADDITIONAL ELECTRIC TRANSFER FOR PAIR OF DOORS NOT INCLUDED.				
	SINGLE				
	HARDWARE ONLY (NO DOOR PREP)	138242		\$360.00	
	FRAME PREP	138243		\$104.00	
	PAIR				
	HARDWARE + DOOR PREP	138244		\$464.00	
	FRAME PREP (N/A WITH PAIRS)	—		—	
	EXIT INDICATOR				
	HARDWARE + DOOR PREP	138222	80.00	80.00	80.00
	MS CYLINDER GUARD (FOR USE WITH KAWNEER STD. CYLINDERS) NOTE: N/A WITH EXIT DEVICES.				
	HARDWARE + DOOR PREP	138224	70.00	70.00	70.00
	CYLINDER FOR MS & LATCH LOCKS PRICE INCLUDES: 1. HARDWARE + DOOR PREP.				
	KEYED INDIVIDUALLY	138670	9.00	9.00	9.00
	KEYED IN PAIRS (INCLUDES 2-CYLINDER)	138671	18.00	18.00	18.00
	KEYED ALIKE (IN GROUPS OF 50)	138672	9.00	9.00	9.00
	THUMB TURN FOR MS LOCKS NOTE: N/A WITH EXIT DEVICES AND 4510 LATCH LOCKS.				
	USE IN PLACE OF CYLINDER	138225	9.00	9.00	9.00

Laws and building and safety codes governing the design and use of glazed entrance, window, and curtain wall products vary widely. Kawneer does not control the selection of product configurations, operating hardware, or glazing materials, and assumes no responsibility therefor.

Kawneer reserves the right to change configuration without prior notice when deemed necessary for product improvement.

© Kawneer Company, Inc., 2009

- NOTES:**
1. EXIT DEVICE OPTIONS DO NOT INCLUDE THE CYLINDERS OR PULL HANDLES. SELECT CYLINDERS AND PULL HANDLES SEPARATELY.
 2. REFER TO THE GENERAL INFORMATION SECTION FOR HARDWARE COLOR COMBINATIONS.
 3. PRICES ARE FOR 3'0" X 7'0" DOOR LEAF. FOR SPECIAL SIZE CONCEALED PANICS USE PART 138667 AND ADD \$60.00 LIST PER LEAF.

CONCEALED EXIT DEVICE HARDWARE OPTIONS

NOTE: HARDWARE + DOOR PREPARATION PRICES ARE PER LEAF, DOUBLE FOR PAIRS OF DOORS.

	PART NO.	FABRICATED PRICE			
		#17 GRP	#40 GRP	#29 GRP	
 <p>KAWNEER 1686 CONCEALED ROD EXIT DEVICE TOUCHBAR EXIT DEVICE.</p>					
	HARDWARE + DOOR PREP FRAME PREP	138645 138646	475.00	490.00 \$35.00	----
 <p>CYLINDER FOR EXIT DEVICES (FOR USE WITH KAWNEER 1686 TOUCHBAR EXIT DEVICE) NOTE: N/A WITH PANELINE TYPE EXIT DEVICE.</p>					
	KEYED INDIVIDUALLY	138643	50.00	50.00	50.00
	KEYED ALIKE (IN GROUPS OF 50)	138644	50.00	50.00	50.00
 <p>DOR-O-MATIC 1690 EXIT DEVICE TOUCHBAR EXIT DEVICE.</p>					
	HARDWARE + DOOR PREP FRAME PREP	138652 138651	\$ 585.00	\$ 600.00 \$35.00	\$ 690.00
 <p>DOR-O-MATIC 1490 CONCEALED ROD EXIT DEVICE TOUCHBAR EXIT DEVICE.</p> <p>PRICE DOES NOT INCLUDE CYLINDER CARTRIDGE, SELECT CYLINDER CARTRIDGE BELOW.</p>					
	HARDWARE + DOOR PREP FRAME PREP	138653 138651	1,200.00	1,210.00 \$35.00	1,240.00
 <p>DOR-O-MATIC 1990 CONCEALED ROD EXIT DEVICE CRASH BAR EXIT DEVICE. KAWNEER CONCEALED EXIT DEVICE.</p>					
	HARDWARE + DOOR PREP FRAME PREP	138650 138651	585.00	600.00 \$35.00	690.00
 <p>CYLINDER FOR EXIT DEVICES (FOR USE WITH DOR-O-MATIC 1690 AND 1990 EXIT DEVICES) NOTE: N/A WITH PANELINE TYPE EXIT DEVICES.</p>					
	KEYED INDIVIDUALLY	138673	12.00	12.00	12.00
	KEYED ALIKE (IN GROUPS OF 50)	138674	12.00	12.00	12.00
 <p>DOR-O-MATIC CYLINDER CARTRIDGES (FOR USE WITH DOR-O-MATIC 1490 EXIT DEVICES) USE (1) CARTRIDGE FOR EITHER SINGLE OR PAIRS OF DOORS. PRICE INCLUDES CYLINDER.</p>					
	NIGHT LATCH	138675	175.00	175.00	175.00
	HOLD OPEN	138676	175.00	175.00	175.00

Laws and building and safety codes governing the design and use of glazed entrance, window, and curtain wall products vary widely. Kawneer does not control the selection of product configurations, operating hardware, or glazing materials, and assumes no responsibility therefor.

Kawneer reserves the right to change configuration without prior notice when deemed necessary for product improvement.

© Kawneer Company, Inc., 2009



EC-97912-05

CONCEALED EXIT DEVICES AND ACCESSORIES

NOTES:

1. EXIT DEVICE OPTIONS DO NOT INCLUDE THE CYLINDERS OR PULL HANDLES. SELECT CYLINDERS AND PULL HANDLES SEPARATELY.
2. REFER TO THE GENERAL INFORMATION SECTION FOR HARDWARE COLOR COMBINATIONS.
3. PRICES ARE FOR 3'0" X 7'0" DOOR LEAF. FOR SPECIAL SIZE CONCEALED PANICS USE PART 138667 AND ADD **\$60.00** LIST PER LEAF.

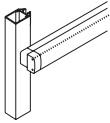
CONCEALED EXIT DEVICE HARDWARE OPTIONS**NOTE:** HARDWARE + DOOR PREPARATION PRICES ARE PER LEAF, DOUBLE FOR PAIRS OF DOORS.

		PART NO.	FABRICATED PRICE		
			#17 GRP	#40 GRP	#29 GRP
	ADAMS RITE 8600 CONCEALED PANIC				
	HARDWARE + DOOR PREP	031820	\$638.00	\$715.00	\$800.00
	FRAME PREP	031826	\$35.00		
	ESCUTCHEON PLATE CYLINDER GUARD (FOR USE WITH ADAMS RITE 8600 CONCEALED PANICS, WHEN CYLINDER IS REQUIRED.)				
	HARDWARE + DOOR PREP	031819	50.00	50.00	50.00
	CYLINDER FOR ADAMS RITE 8600 PRICE INCLUDES: HARDWARE AND DOOR PREP.				
	KEYED INDIVIDUALLY	138670	9.00	9.00	9.00
	KEYED ALIKE (IN GROUPS OF 50)	138672	9.00	9.00	9.00

Laws and building and safety codes governing the design and use of glazed entrance, window, and curtain wall products vary widely. Kawneer does not control the selection of product configurations, operating hardware, or glazing materials, and assumes no responsibility therefor.

Kawneer reserves the right to change configuration without prior notice when deemed necessary for product improvement.

© Kawneer Company, Inc., 2009

RIM EXIT DEVICES AND ACCESSORIES

EC-97912-05

NOTES:

1. EXIT DEVICE OPTIONS DO NOT INCLUDE THE CYLINDERS OR PULL HANDLES. SELECT CYLINDERS AND PULL HANDLES SEPARATELY.
2. REFER TO THE GENERAL INFORMATION SECTION FOR HARDWARE COLOR COMBINATIONS.
3. PRICES ARE FOR 3'0" WIDE DOOR LEAF. FOR SPECIAL SIZE RIM PANICS USE PART 138668 AND ADD \$50.00 LIST PER LEAF.
4. RIM EXIT DEVICES NOT COMPATIBLE ON CENTER HUNG DOORS WITH STANDARD FRAME OFFERINGS.

RIM EXIT DEVICE HARDWARE OPTIONS

NOTE: HARDWARE + DOOR PREPARATION PRICES ARE PER LEAF, DOUBLE FOR PAIRS OF DOORS.

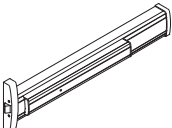
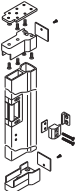
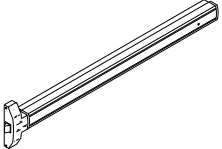
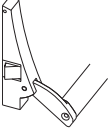
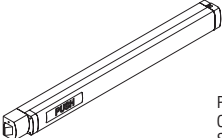
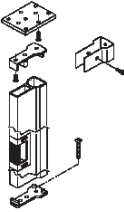
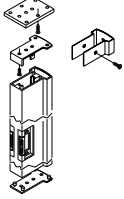
	PART NO.	FABRICATED PRICE			
		#17 GRP	#40 GRP	#29 GRP	
 <p>KAWNEER 1786 RIM EXIT DEVICE TOUCHBAR RIM EXIT DEVICE.</p>	HARDWARE + DOOR PREP	138835	\$398.00	\$ 415.00	---
	FRAME PREP (SINGLE DOOR)	138836		\$ 35.00	
 <p>RM-86 REMOVABLE MULLION (FOR USE WITH PAIRS OF 1590 RIM EXIT DEVICES) MAXIMUM HEIGHT OF 8'0"</p>	FOR KAWNEER 1786 PANIC UP TO 7'0" HARDWARE	133586	1515.00	1575.00	----
	UP TO 8'0" HARDWARE	133587	1548.00	1610.00	----
	FRAME PREP	138837		\$170.00	
 <p>DOR-O-MATIC 1790 RIM EXIT DEVICE TOUCHBAR RIM EXIT DEVICE.</p>	HARDWARE + DOOR PREP	138657	\$528.00	\$ 560.00	\$ 590.00
	FRAME PREP (SINGLE DOOR)	138655		\$ 35.00	
 <p>DOR-O-MATIC 2090 RIM EXIT DEVICE CRASH BAR EXIT DEVICE.</p>	HARDWARE + DOOR PREP	138654	528.00	560.00	590.00
	FRAME PREP (SINGLE DOOR)	138655		\$ 35.00	
 <p>DOR-O-MATIC 1590 RIM EXIT DEVICE TOUCHBAR EXIT DEVICE.</p> <p>PRICE DOES NOT INCLUDE CYLINDER CARTRIDGE, SELECT CYLINDER CARTRIDGE BELOW.</p>	HARDWARE + DOOR PREP	138656	940.00	990.00	1,104.00
	FRAME PREP (SINGLE DOOR)	138655		\$ 35.00	
 <p>DOR-O-MATIC RM-170/RM-70 REMOVABLE MULLION (FOR USE WITH PAIRS OF STD. & 2090 RIM EXIT DEVICES)</p> <p>PRICE INCLUDES (2) INTERLOCKING MULLION STABILIZERS MAXIMUM HEIGHT OF 8'0".</p>	RM-170 FOR STD. PANIC UP TO 7'0" HARDWARE	133486	850.00	880.00	982.00
	UP TO 8'0" HARDWARE	133487	985.00	1,015.00	1,132.00
	FRAME PREP	138658		\$170.00	
	RM-70 FOR 2090 PANIC UP TO 7'0" HARDWARE	033542	850.00	880.00	982.00
	UP TO 8'0" HARDWARE	033543	985.00	1,015.00	1,132.00
	FRAME PREP	138658		\$170.00	
 <p>DOR-O-MATIC RM-150 REMOVABLE MULLION (FOR USE WITH PAIRS OF 1590 RIM EXIT DEVICES) MAXIMUM HEIGHT OF 8'0".</p>	RM-150 FOR 1590 PANIC UP TO 7'0" HARDWARE	133375	850.00	880.00	982.00
	UP TO 8'0" HARDWARE	133376	985.00	1,015.00	1,132.00
	FRAME PREP	138658		\$170.00	

Laws and building and safety codes governing the design and use of glazed entrance, window, and curtain wall products vary widely. Kawneer does not control the selection of product configurations, operating hardware, or glazing materials, and assumes no responsibility therefor.

Kawneer reserves the right to change configuration without prior notice when deemed necessary for product improvement.

© Kawneer Company, Inc., 2009

EC-97912-05



RIM EXIT DEVICES AND ACCESSORIES

NOTES:

- EXIT DEVICE OPTIONS DO NOT INCLUDE THE CYLINDERS OR PULL HANDLES. SELECT CYLINDERS AND PULL HANDLES SEPARATELY.
- REFER TO THE GENERAL INFORMATION SECTION FOR HARDWARE COLOR COMBINATIONS.
- PRICES ARE FOR 3'0" WIDE DOOR LEAF. FOR SPECIAL SIZE RIM PANICS USE PART 138668 AND ADD \$50.00 LIST PER LEAF.
- RIM EXIT DEVICES NOT COMPATIBLE ON CENTER HUNG DOORS WITH STANDARD FRAME OFFERINGS.

RIM EXIT DEVICE HARDWARE OPTIONS

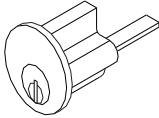
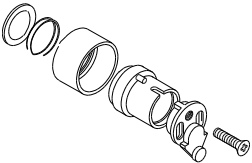
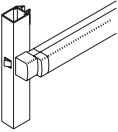
NOTE: HARDWARE + DOOR PREPARATION PRICES ARE PER LEAF, DOUBLE FOR PAIRS OF DOORS.

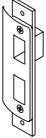
		FABRICATED PRICE			
		PART NO.	#17 GRP	#40 GRP	#29 GRP
 <p>CYLINDER FOR EXIT DEVICES (FOR USE WITH DOR-O-MATIC 1790 AND 2090 EXIT DEVICES) NOTE: N/A WITH PANELINE TYPE EXIT DEVICES.</p>	KEYED INDIVIDUALLY	138673	12.00	12.00	12.00
	KEYED ALIKE (IN GROUPS OF 50)	138674	12.00	12.00	12.00
	DOR-O-MATIC CYLINDER CARTRIDGES (FOR USE WITH DOR-O-MATIC 1590 EXIT DEVICES) USE (1) CARTRIDGE FOR EITHER SINGLE OR PAIRS OF DOORS. PRICE INCLUDES CYLINDER.				
	NIGHT LATCH	138675	175.00	175.00	175.00
	HOLD OPEN	138676	175.00	175.00	175.00
	ADAMS RITE 8400 MORTISE TYPE PANIC EXIT DEVICE				
	HARDWARE + DOOR PREP	031821	\$638.00	\$715.00	800.00
	FRAME PREP	031829		\$35.00	
CYLINDER FOR ADAMS RITE 8400					
	KEYED INDIVIDUALLY	138670	9.00	9.00	9.00
	PRICE INCLUDES: HARDWARE AND DOOR PREP	KEYED ALIKE (IN GROUPS OF 50)	138672	9.00	9.00
STRIKEPLATE					
	HARDWARE + DOOR PREP	031822		\$58.00	
	SINGLE – FLAT STRIKEPLATE				
	FRAME PREP	031829		\$58.00	
	PAIR – RADIUS STRIKEPLATE				





Laws and building and safety codes governing the design and use of glazed entrance, window, and curtain wall products vary widely. Kawneer does not control the selection of product configurations, operating hardware, or glazing materials, and assumes no responsibility therefor.

Kawneer reserves the right to change configuration without prior notice when deemed necessary for product improvement.

© Kawneer Company, Inc., 2009

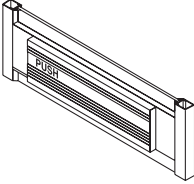
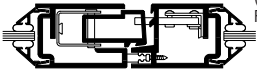
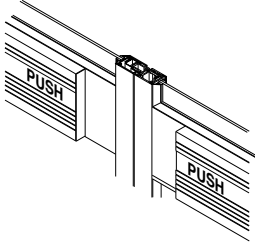
- NOTES:**
1. EXIT DEVICE OPTIONS DO NOT INCLUDE THE CYLINDERS OR PULL HANDLES. SELECT CYLINDERS AND PULL HANDLES SEPARATELY.
 2. REFER TO THE GENERAL INFORMATION SECTION FOR HARDWARE COLOR COMBINATIONS.

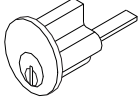
EXIT DEVICE HARDWARE OPTIONS

	PART NO.	FABRICATED PRICE			
		#17 GRP	#40 GRP	#29 GRP	
 <p>PANELINE® EXIT DEVICE INCLUDES PANELINE CR-90 CONCEALED ROD DEVICE. PANELINE® EL(REFER TO ACCESS CONTROL SECTION)</p> <p>SELECT CPN, CO-9 OR CO-12 PULL SEPARATELY. NOTE: CO-9 AND CO-12 NOT RECOMMENDED FOR USE ON 190 NARROW STILE DOORS. (PRICE IS FOR ONE LEAF)</p>	STD. 3'0" WIDTH DOOR LEAF HARDWARE + DOOR PREP	138659	\$ 840.00	\$ 880.00	\$ 985.00
	NON 3'0" WIDE DOOR LEAF HARDWARE + DOOR PREP	138660	915.00	955.00	1,060.00
	SINGLE RX SWITCH	138690		225.00	
	DOUBLE RX SWITCH	138691		300.00	
	FRAME PREP	138651		\$35.00	
<p>DUMMY PANELINE® RAIL ADD TO DOORS WITHOUT LOCKING HARDWARE ONLY.</p> <p>PRICE INCLUDES DUMMY RAIL ASSEMBLY INSTALLED IN DOOR. SELECT CPN, CO-9 OR CO-12 PULL SEPARATELY. MATCHES APPEARANCE OF ACTIVE PANEL IN DOGGED POSITION. (PRICE IS FOR ONE LEAF)</p>	HARDWARE + DOOR PREP	138661	492.00	518.00	580.00
	 <p>PANIC GUARD® EXIT DEVICE (INCLUDES DOR-O-MATIC 1990 EXIT DEVICE WITH CRASH BAR) FOR USE ON PAIRS OF DOORS ONLY</p>	STD. 7'0" HEIGHT DOOR LEAF HARDWARE + DOOR PREP	138662	1,806.00	1,900.00
NON 7'0" HEIGHT DOOR LEAF HARDWARE + DOOR PREP		138663	1,986.00	2,080.00	2,300.00
FRAME PREP		138664		\$70.00	
 <p>PANELINE/PANIC GUARD® EXIT DEVICE (USE ON PAIRS OF DOORS ONLY)</p>	STD. 3'0" X 7'0" DOOR LEAF HARDWARE + DOOR PREP	138665	2,646.00	2,780.00	3,105.00
	NON 3'0" X 7'0" DOOR LEAF HARDWARE + DOOR PREP	138666	2,901.00	3,035.00	3,360.00
	FRAME PREP	138664		\$70.00	
 <p>CYLINDER FOR PANELINE® EXIT DEVICES NOTE: USE WITH PANELINE® AND PANELINE/PANIC GUARD®</p>	KEYED INDIVIDUALLY	138679	12.00	12.00	12.00
	KEYED ALIKE (IN GROUPS OF 50)	138680	12.00	12.00	12.00
 <p>CYLINDER FOR STANDARD EXIT DEVICES NOTE: USE WITH PANIC GUARD®</p>	KEYED INDIVIDUALLY	138673	12.00	12.00	12.00
	KEYED ALIKE (IN GROUPS OF 50)	138674	12.00	12.00	12.00
	 <p>PANELINE® CYLINDER GUARD NOTE: FOR PANELINE® EXIT DEVICE WITH CPN PULL.</p>		138681	55.00	55.00

Laws and building and safety codes governing the design and use of glazed entrance, window, and curtain wall products vary widely. Kawneer does not control the selection of product configurations, operating hardware, or glazing materials, and assumes no responsibility therefor.

Kawneer reserves the right to change configuration without prior notice when deemed necessary for product improvement.

© Kawneer Company, Inc., 2009

**THIS PAGE LEFT
INTENTIONALLY
BLANK**

Laws and building and safety codes governing the design and use of glazed entrance, window, and curtain wall products vary widely. Kawneer does not control the selection of product configurations, operating hardware, or glazing materials, and assumes no responsibility therefor.

Kawneer reserves the right to change configuration without prior notice when deemed necessary for product improvement.
© Kawneer Company, Inc., 2009

AUTO SHOWROOM ACCESSORIES

	PART NO.	PRICE		
RISER BLOCK STANDARD FOR BI-FOLD DOOR AND LARGE INACTIVE DOOR LEAF.	138729	\$ 55.00 (NO FINISH)		
CASTER OPTIONAL FOR BI-FOLD DOOR AND LARGE INACTIVE DOOR LEAF.	138730	80.00 (NO FINISH)		
SPECIAL WIDTH AUTO SHOWROOM DOOR FOR EACH ADDITIONAL 1" INCREMENT.	138234	152.00 (NO FINISH)		
AUTO SHOWROOM DOOR BOTTOM WEATHERING VARIABLE TO 5'-0" FOR LARGE INACTIVE DOOR LEAF.	200407	#17 GRP 32.00	#40 GRP 36.00	#29 GRP 40.00

STANDARD AUTO SHOWROOM SPECIFICATIONS

SWING TYPE ENTRANCES

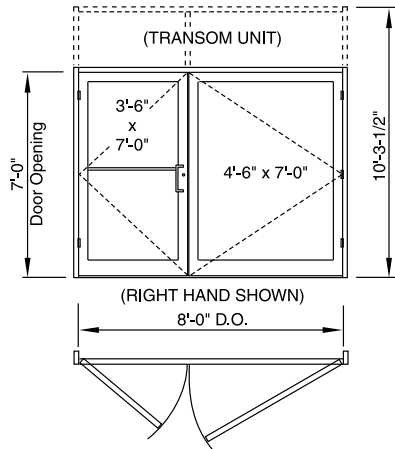

STANDARD CONFIGURATION INCLUDES:

ACTIVE LEAF =

3'6" X 7'0" 190 ACTIVE DOOR LEAF WITH STYLE CO-9 PUSH/PULL HARDWARE, ONE SET BUTT HINGES, MS LOCK WITH CYLINDERS AND SURFACE CLOSER.

INACTIVE LEAF =

4'6" X 7'0" 190 INACTIVE DOOR LEAF WITH FLUSH BOLTS, RISER BLOCK, AND 1½" PAIR BUTT HINGES.

FRAMING =

TRIFAB® VG 450 CENTER FRAME WITH THRESHOLD.

NOTES:

- MAXIMUM INACTIVE DOOR LEAF WIDTH IS 5'0"

BI-FOLD TYPE ENTRANCES

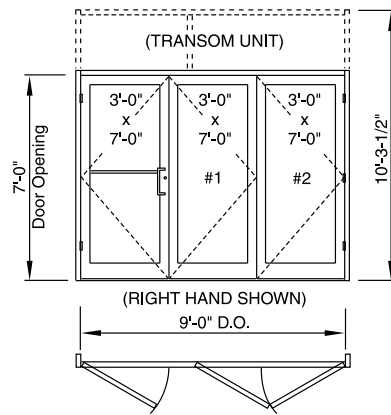

STANDARD CONFIGURATION INCLUDES:

ACTIVE LEAF =

3'0" X 7'0" 190 ACTIVE DOOR LEAF WITH STYLE CO-9 PUSH/PULL HARDWARE, ONE SET BUTT HINGES, MS LOCK WITH CYLINDERS AND SURFACE CLOSER.

INACTIVE LEAF =

3'0" X 7'0" 190 INACTIVE DOOR LEAF #1 WITH FLUSH BOLTS, RISER BLOCK, AND 1 CONTINUOUS HINGE.

INACTIVE LEAF =

3'0" X 7'0" 190 INACTIVE DOOR LEAF #2 WITH FLUSH BOLTS, RISER BLOCK, AND 1½" PAIR BUTT HINGES.

FRAMING =

TRIFAB® VG 450 CENTER FRAME WITH THRESHOLD.

MAXIMUM ALLOWABLE SIZES AND RESTRICTIONS (THIS PAGE):

- NOT RECOMMENDED FOR USE WITH 1" GLASS.
- DOOR OPENING WIDTH TO 9'0"
- OVERALL FRAME HEIGHT OF 8'1¼" WITHOUT TRANSOM.
- (STEEL REINFORCING MAY BE REQUIRED, ADD PRICE ACCORDINGLY FROM PAGE A2/26.)

- DOOR OPENING HEIGHT TO 8'0"
- OVERALL FRAME HEIGHT OF 12'0" WITH TRANSOM.
- FOR HARDWARE OPTIONS NOT LISTED IN THE A2 SECTION OF THE PRICE BOOK, PLEASE CONSULT FACTORY.

Laws and building and safety codes governing the design and use of glazed entrance, window, and curtain wall products vary widely. Kawneer does not control the selection of product configurations, operating hardware, or glazing materials, and assumes no responsibility therefor.

Kawneer reserves the right to change configuration without prior notice when deemed necessary for product improvement.





© Kawneer Company, Inc., 2009

EC-97912-05

ARCHITECTS CLASSIC PUSH/PULL SETS

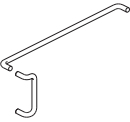
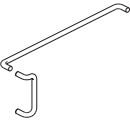
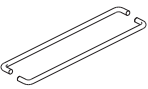
NOTES:

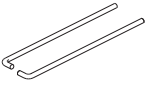
1. PUSH/PULL PRICES ARE **PER LEAF** AND INCLUDE ATTACHMENT SCREWS AND THE PREPARATION TO THE DOOR.
2. FOR PAIRS OF DOORS, (2) SETS ARE REQUIRED.
3. REFER TO THE GENERAL INFORMATION SECTION FOR HARDWARE COLOR COMBINATIONS.

	PART NO.	FINISH GROUP			
		NO. 1	NO. 2	NO. 3	
 STYLE CO-9/CP-II NOT FOR USE ON D/A DOORS	= 3'0"	137700P	\$173.00	\$400.00	\$460.00
	= 3'6"	137701P	188.00	422.00	485.00
	VAR. TO 4'0"	137702P	313.00	672.00	710.00
 STYLE CO-12/CP-II NOT FOR USE ON D/A DOORS	= 3'0"	137706P	188.00	415.00	475.00
	= 3'6"	137707P	203.00	437.00	500.00
	VAR. TO 4'0"	137708P	328.00	687.00	725.00
 STYLE CP-II PUSH BARS (2) NOT FOR USE ON D/A DOORS	= 3'0"	137715P	195.00	437.00	510.00
	= 3'6"	137716P	210.00	466.00	540.00
	VAR. TO 4'0"	137717P	410.00	820.00	952.00
 STYLE CO-9/CP	= 3'0"	137703P	159.00	385.00	444.00
	= 3'6"	137704P	173.00	407.00	466.00
	VAR. TO 4'0"	137705P	244.00	513.00	579.00
 STYLE CO-12/CP	= 3'0"	137709P	173.00	400.00	459.00
	= 3'6"	137710P	188.00	422.00	481.00
	VAR. TO 4'0"	137711P	258.00	527.00	594.00
 STYLE CP PUSH BARS (2)	= 3'0"	137718P	173.00	415.00	488.00
	= 3'6"	137719P	188.00	444.00	532.00
	VAR. TO 4'0"	137720P	258.00	557.00	660.00
 STYLE CO-9/CO-9	PER LEAF	137725P	159.00	348.00	400.00
 STYLE CO-12/CO-12	PER LEAF	137726P	173.00	363.00	415.00
COLOR MATERIAL IDENTIFICATION					
ALUMINUM,	CLEAR ANODIZED		#14		
	BLACK PERMANODIC®		#29		
	DARK BRONZE PERMANODIC®		#40		
STAINLESS STEEL,	US 32			#45	
	US 32D			#46	
BRONZE,	US 10B				#44
BRIGHT BRASS,	PVD (US 3)				#47

Laws and building and safety codes governing the design and use of glazed entrance, window, and curtain wall products vary widely. Kawneer does not control the selection of product configurations, operating hardware, or glazing materials, and assumes no responsibility therefor.

Kawneer reserves the right to change configuration without prior notice when deemed necessary for product improvement.

© Kawneer Company, Inc., 2009



PANIC PULLS

EC-97912-05

NOTES:

1. PUSH/PULL PRICES ARE **PER LEAF** AND INCLUDE ATTACHMENT SCREWS AND THE PREPARATION TO THE DOOR.
2. FOR PAIRS OF DOORS (2) PULLS ARE REQUIRED.
3. REFER TO THE GENERAL INFORMATION SECTION FOR HARDWARE COLOR COMBINATIONS.

PANIC PULLS

		PART NO.	FINISH GROUP		
			NO. 1	NO. 2	NO. 3
	STYLE CO-9				
	FOR ONE (1) STYLE CO-9 PULL HANDLE	137730P	\$101.00	\$207.00	\$233.00
	STYLE CO-12				
	FOR ONE (1) STYLE CO-12 PULL HANDLE	137731P	108.00	214.00	240.00
	STYLE CPN				
	FOR USE WITH RH PANELINE UNIT	137732P			
	FOR USE WITH LH PANELINE UNIT	137733P			
	FOR USE WITH RH DUMMY PANELINE UNIT	137734P			
	FOR USE WITH LH DUMMY PANELINE UNIT	137735P			
	FOR ONE (1) STYLE CPN PULL HANDLE		101.00	N/A	N/A
PUSH BAR FOR AUTO SHOWROOM					
	STYLE CP-II				
	VARIABLE TO 5'-0"				
	FOR USE ON LARGE INACTIVE DOOR LEAF	137740P	276.00	466.00	540.00
					(N/A IN #47)

COLOR MATERIAL IDENTIFICATION

ALUMINUM,	CLEAR ANODIZED	#14		
	BLACK PERMANODIC®	#29		
	DARK BRONZE PERMANODIC®	#40		
STAINLESS STEEL,	US 32		#45	
	US 32D		#46	
BRONZE,	US 10B			#44
BRIGHT BRASS,	PVD (US 3)			#47

Laws and building and safety codes governing the design and use of glazed entrance, window, and curtain wall products vary widely. Kawneer does not control the selection of product configurations, operating hardware, or glazing materials, and assumes no responsibility therefor.

Kawneer reserves the right to change configuration without prior notice when deemed necessary for product improvement.

© Kawneer Company, Inc., 2009

EC-97912-05

TRIFAB® 400 FRAMING SYSTEM (1¾" X 4")

PRICE INCLUDES:

1. FABRICATION OF SPECIAL FRAMES (DOOR FRAMING/SIDELIGHTS/FIXED AREAS, ETC.).
2. APPLICABLE GLASS STOPS.
3. GLAZING GASKETS.
4. FRAME CLIPS & SCREWS (JOINT CHARGES INCLUDED).
5. FRAMING IS FACTORY FABRICATED AND SHIPPED K.D.

NOT INCLUDED:







1. PERIMETER FASTENERS OR PREPARATION.
2. PERIMETER RECEPTORS OR SILL FLASHING.
3. BRAKES OR SPECIAL FILLERS.
4. SASH OR SASH ATTACHMENT.
5. ASSEMBLY OF FRAME.

PRICING NOTES:





1. DETERMINE THE TOTAL LINEAR FEET OF FRAMING REQUIRED AND MULTIPLY BY THE LINEAR PER FOOT CHARGE OF THE FRAMING MEMBERS YOU SELECT (TO THE NEXT LARGER FOOT).
2. ADD THE FRAME PREPARATION CHARGES FOR ANY OPTIONS REQUIRED.

3. CONSULT ARCHITECTURAL DETAILS FOR STRUCTURAL LIMITATIONS.
4. FOR JOINTS OTHER THAN 90°, CONTACT THE FACTORY FOR PRICING.





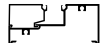

TRIFAB® 400 FRAMING SYSTEM (1¾" X 4")**SCREW SPLINE**

								
	MULLION	HEAD, JAMB	HORIZONTAL	SILL	EXPANSION MULLION	SILL FLASHING		
PART NO.	4009111	4009112	4009113	4009114	4009115 ⁽¹⁾	4009147		
#17 GRP	\$18.16	\$13.76	\$21.51	\$15.50	\$19.86	\$5.53		
#40 GRP	19.12	14.48	22.64	16.32	20.91	6.11		
#29 GRP	21.41	16.22	25.36	18.28	23.42	6.84		





SHEAR BLOCK

								
	MULLION	HEAD, JAMB	HORIZONTAL	SILL	EXPANSION MULLION	SILL FLASHING		
PART NO.	4009117	4009118	4009119	4009114	4009115 ⁽¹⁾	4009147		
#17 GRP	\$13.92	\$13.43	\$19.48	\$15.50	\$19.86	\$5.53		
#40 GRP	14.65	14.14	20.51	16.32	20.91	6.11		
#29 GRP	16.41	15.84	22.97	18.28	23.42	6.84		

SPECIAL MOLDINGS

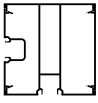
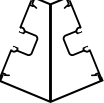
						ADD FOR EACH 3' OVER 10' PER FOOT		
	DOOR JAMB	HEADER/T-BAR	STANDARD SIDELIGHT BASE	TALL SIDELIGHT BASE	BUILT-UP SIDELIGHT BASE		STD. 4" THRESHOLD 10 (MILL)	OPTIONAL 6¾" THRESHOLD 10 (MILL)
PART NO.	4009120 ⁽²⁾	4009121 ⁽²⁾	4509141	4509142	4509143	4509144	4509145	4509146
#17 GRP	\$15.40	\$20.81	\$21.20	\$26.58	\$ 86.49	\$6.12	\$4.36	\$10.02
#40 GRP	16.21	21.91	22.32	27.98	91.04	6.44	4.36	10.02
#29 GRP	18.16	24.54	25.00	31.34	101.96	7.21	4.36	10.02

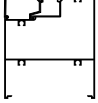
SPECIAL MOLDINGS

								
	0-25° CORNER	90° CORNER	135° CORNER	MULL. HALF FOR VAR. CORNER	4" X 4½" SIDELIGHT BASE	STEEL REINFORCING		
PART NO.	4009122	4009123	4009124	4009125	4009126	4009110		
#17 GRP	\$29.92	\$29.86	\$30.26	\$12.26	\$28.07	\$28.00		
#40 GRP	31.49	31.43	31.85	12.90	29.55	28.00		
#29 GRP	35.27	35.20	35.67	14.45	33.10	28.00		

(1) STEEL REINFORCEMENT NOT AVAILABLE FOR EXPANSION MULLION.

(2) SPECIFY S/A OR D/A WHEN ORDERING.

Laws and building and safety codes governing the design and use of glazed entrance, window, and curtain wall products vary widely. Kawneer does not control the selection of product configurations, operating hardware, or glazing materials, and assumes no responsibility therefor.

Kawneer reserves the right to change configuration without prior notice when deemed necessary for product improvement.

© Kawneer Company, Inc., 2009

TRIFAB® VG 450 FRAMING SYSTEM (1¼" X 4½" CENTER)

EC-97912-05

PRICE INCLUDES:

1. FABRICATION OF SPECIAL FRAMES (DOOR FRAMING/SIDELIGHTS/FIXED AREAS, ETC.).
2. APPLICABLE GLASS STOPS.
3. GLAZING GASKETS.
4. FRAME CLIPS & SCREWS (JOINT CHARGES INCLUDED).
5. FRAMING IS FACTORY FABRICATED AND SHIPPED K.D.

NOT INCLUDED:







1. PERIMETER FASTENERS OR PREPARATION.
2. PERIMETER RECEPTORS OR SILL FLASHING.
3. BRAKES OR SPECIAL FILLERS.
4. SASH OR SASH ATTACHMENT.
5. ASSEMBLY OF FRAME.

PRICING NOTES:



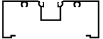
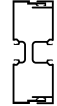

1. DETERMINE THE TOTAL LINEAR FEET OF FRAMING REQUIRED AND MULTIPLY BY THE LINEAR PER FOOT CHARGE OF THE FRAMING MEMBERS YOU SELECT (TO THE NEXT LARGER FOOT).
2. ADD THE FRAME PREPARATION CHARGES FOR ANY OPTIONS REQUIRED.

TRIFAB® VG 450 FRAMING SYSTEM (1¼" X 4½" CENTER)



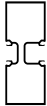
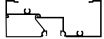

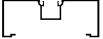
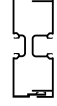
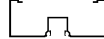

SCREW SPLINE

								
	MULLION	HEAD	HORIZONTAL	SILL/JAMB	EXPANSION MULLION	TRANSOM HEAD	SILL FLASHING	HP SILL FLASHING
PART NO.	4509111	4509112	4509119	4509114	4509115	4509118	4509147	4519148
#17 GRP	\$19.81	\$16.57	\$19.86	\$15.46	\$22.20	\$14.44	\$5.72	\$ 8.85
#40 GRP	20.85	17.44	20.91	16.27	23.37	15.20	6.46	9.72
#29 GRP	23.35	19.53	23.42	18.22	26.17	17.02	7.15	10.53

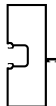
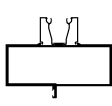

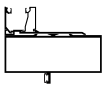

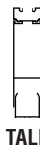

SHEAR BLOCK

								
	MULLION	HEAD	HORIZONTAL	SILL/JAMB	EXPANSION MULLION	TRANSOM HEAD	SILL FLASHING	HP SILL FLASHING
PART NO.	4509117	4509112	4509119	4509118	4509115	4509118	4509147	4519148
#17 GRP	\$15.77	\$16.57	\$19.86	\$14.44	\$22.20	\$14.44	\$5.72	\$ 8.85
#40 GRP	16.60	17.44	20.91	15.20	23.37	15.20	6.46	9.72
#29 GRP	18.59	19.53	23.42	17.02	26.17	17.02	7.15	10.53

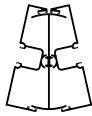
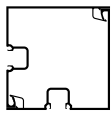
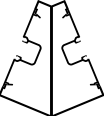
SPECIAL MOLDINGS

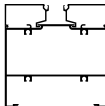
								ADD FOR EACH 3' OVER 10' PER FOOT
	DOOR JAMB ⁽²⁾	HEADER/T-BAR ⁽²⁾	FRONT/BACK ⁽¹⁾ DOOR JAMB ⁽²⁾	FRONT/BACK ⁽¹⁾ T-BAR ⁽²⁾	STANDARD SIDELIGHT BASE	TALL SIDELIGHT BASE	BUILT-UP SIDELIGHT BASE	
PART NO.	4509120	4509121	4509170	4509171	4509141	4509142	4509143	4509144
#17 GRP	\$16.30	\$22.25	\$20.58	\$26.88	\$21.20	\$26.58	\$ 86.49	\$6.12
#40 GRP	17.16	23.42	21.64	28.24	22.32	27.98	91.04	6.44
#29 GRP	19.22	26.23	23.13	30.14	25.00	31.34	101.96	7.21

SPECIAL MOLDINGS

								
	0-25° CORNER	90° CORNER	135° CORNER	MULL. HALF FOR VAR. CORNER	4½" X 4½" SIDELIGHT BASE	STEEL REINFORCING	STD. 4" THRESHOLD 10 (MILL)	OPTIONAL 6¾" THRESHOLD 10 (MILL)
PART NO.	4509122	4509123	4509124	4509125	4509126	4509110	4509145	4509146
#17 GRP	\$33.83	\$32.27	\$32.39	\$13.18	\$32.79	\$35.00	\$4.36	\$10.02
#40 GRP	35.61	33.97	34.09	13.87	34.52	35.00	4.36	10.02
#29 GRP	39.88	38.05	38.18	15.53	38.66	35.00	4.36	10.02

⁽¹⁾ SPECIFY FRONT OR BACK GLASS PLANE WHEN ORDERING.

⁽²⁾ SPECIFY S/A OR D/A WHEN ORDERING.

Laws and building and safety codes governing the design and use of glazed entrance, window, and curtain wall products vary widely. Kawneer does not control the selection of product configurations, operating hardware, or glazing materials, and assumes no responsibility therefor.

Kawneer reserves the right to change configuration without prior notice when deemed necessary for product improvement.

© Kawneer Company, Inc., 2009

EC-97912-05

TRIFAB® VG 451 FRAMING SYSTEM (2" X 4½" CENTER)

PRICE INCLUDES:

1. FABRICATION OF SPECIAL FRAMES (DOOR FRAMING/SIDELIGHTS/FIXED AREAS, ETC.).
2. APPLICABLE GLASS STOPS.
3. GLAZING GASKETS.
4. FRAME CLIPS & SCREWS (JOINT CHARGES INCLUDED).
5. FRAMING IS FACTORY FABRICATED AND SHIPPED K.D.







NOT INCLUDED:

1. PERIMETER FASTENERS OR PREPARATION.
2. PERIMETER RECEPTORS OR SILL FLASHING.
3. BRAKES OR SPECIAL FILLERS.
4. SASH OR SASH ATTACHMENT.
5. ASSEMBLY OF FRAME.

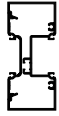



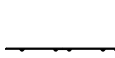
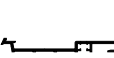

PRICING NOTES:

1. DETERMINE THE TOTAL LINEAR FEET OF FRAMING REQUIRED AND MULTIPLY BY THE LINEAR PER FOOT CHARGE OF THE FRAMING MEMBERS YOU SELECT (TO THE NEXT LARGER FOOT).
2. ADD THE FRAME PREPARATION CHARGES FOR ANY OPTIONS REQUIRED.
3. CONSULT ARCHITECTURAL DETAILS FOR STRUCTURAL LIMITATIONS.
4. FOR JOINTS OTHER THAN 90°, CONTACT THE FACTORY FOR PRICING.

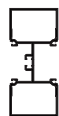

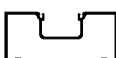

TRIFAB® VG 451 FRAMING SYSTEM (2" X 4½" CENTER)**SCREW SPLINE**

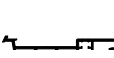
								
	MULLION	HEAD	HORIZONTAL ⁽³⁾	SILL/JAMB ⁽⁴⁾	EXPANSION MULLION	TRANSOM HEAD	SILL FLASHING	HP SILL FLASHING
PART NO.	4519111	4519112	4519119	4519114	4519115	4519118	4509147	4519148
#17 GRP	\$20.18	\$17.15	\$20.28	\$16.20	\$23.31	\$15.34	\$5.72	\$ 8.85
#40 GRP	21.24	18.05	21.35	17.05	24.54	16.15	6.46	9.72
#29 GRP	23.79	20.22	23.91	19.10	27.48	18.09	7.15	10.53

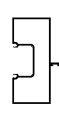

SHEAR BLOCK

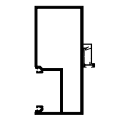
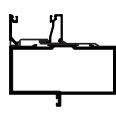
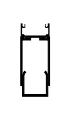
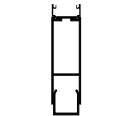
								
	MULLION	HEAD	HORIZONTAL ⁽³⁾	SILL/JAMB ⁽⁴⁾	EXPANSION MULLION	TRANSOM HEAD	SILL FLASHING	HP SILL FLASHING
PART NO.	4519117	4519112	4519119	4519118	4519115	4519118	4509147	4519148
#17 GRP	\$16.46	\$17.15	\$20.28	\$15.34	\$23.31	\$15.34	\$5.72	\$ 8.85
#40 GRP	17.33	18.05	21.35	16.15	24.54	16.15	6.46	9.72
#29 GRP	19.41	20.22	23.91	18.09	27.48	18.09	7.15	10.53

SPECIAL MOLDINGS

								ADD FOR EACH 3" OVER 10" PER FOOT
	DOOR JAMB ⁽²⁾	HEADER/T-BAR ⁽²⁾⁽⁵⁾	FRONT/BACK ⁽¹⁾ DOOR JAMB ⁽²⁾	FRONT/BACK ⁽¹⁾ T-BAR ⁽²⁾⁽⁴⁾	STANDARD SIDELIGHT BASE ⁽⁴⁾	TALL SIDELIGHT BASE ⁽⁴⁾	BUILT-UP SIDELIGHT BASE	
PART NO.	4519120	4519121	4519170	4519171	4519141	4519142	4519143	4519144
#17 GRP	\$16.94	\$22.52	\$21.22	\$27.15	\$21.20	\$26.58	\$ 86.49	\$6.12
#40 GRP	17.83	23.70	22.28	28.51	22.32	27.98	91.04	6.44
#29 GRP	19.97	26.54	23.77	30.41	25.00	31.34	101.96	7.21

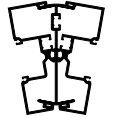
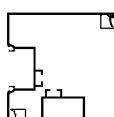
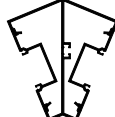
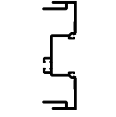
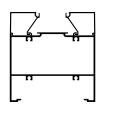
SPECIAL MOLDINGS

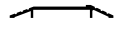
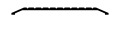
								
	0-25° CORNER	90° CORNER	135° CORNER	MULL. HALF FOR VAR. CORNER	4½" X 4½" SIDELIGHT BASE ⁽⁴⁾	CENTER DOOR JAMB STEEL REINFORCING	STD. 4" THRESHOLD 10 (MILL)	OPTIONAL 6¾" THRESHOLD 10 (MILL)
PART NO.	4519122	4519123	4519124	4519125	4519126	4509110	4509145	4509146
#17 GRP	\$33.42	\$32.16	\$33.08	\$13.92	\$32.79	\$35.00	\$4.36	\$10.02
#40 GRP	35.18	33.85	34.82	14.65	34.52	35.00	4.36	10.02
#29 GRP	39.40	37.91	39.00	16.41	38.66	35.00	4.36	10.02

(1) SPECIFY FRONT OR BACK GLASS PLANE WHEN ORDERING.

(2) SPECIFY S/A OR D/A WHEN ORDERING.

(3) TO SUBSTITUTE SILICONE SETTING BLOCKS, USE PART NUMBER 138016, AND ADD \$1.00 PER FOOT.

(4) TO SUBSTITUTE SILICONE SETTING BLOCKS, USE PART NUMBER 138017, AND ADD \$3.00 PER FOOT.

(5) TO SUBSTITUTE SILICONE SETTING BLOCKS, USE PART NUMBER 138018, AND ADD \$4.40 PER FOOT.

Laws and building and safety codes governing the design and use of glazed entrance, window, and curtain wall products vary widely. Kawneer does not control the selection of product configurations, operating hardware, or glazing materials, and assumes no responsibility therefor.

Kawneer reserves the right to change configuration without prior notice when deemed necessary for product improvement.

© Kawneer Company, Inc., 2009

TRIFAB® VG 451T FRAMING SYSTEM (2" X 4½" CENTER)

EC-97912-05

PRICE INCLUDES:

1. FABRICATION OF SPECIAL FRAMES (DOOR FRAMING/SIDELIGHTS/FIXED AREAS, ETC.).
2. APPLICABLE GLASS STOPS.
3. GLAZING GASKETS.
4. FRAME CLIPS & SCREWS (JOINT CHARGES INCLUDED).
5. FRAMING IS FACTORY FABRICATED AND SHIPPED K.D.

NOT INCLUDED:





1. PERIMETER FASTENERS OR PREPARATION.
2. PERIMETER RECEPTORS OR SILL FLASHING.
3. BRAKES OR SPECIAL FILLERS.
4. SASH OR SASH ATTACHMENT.
5. ASSEMBLY OF FRAME.

PRICING NOTES:





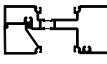
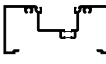

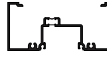
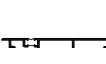
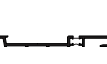

1. DETERMINE THE TOTAL LINEAR FEET OF FRAMING REQUIRED AND MULTIPLY BY THE LINEAR PER FOOT CHARGE OF THE FRAMING MEMBERS YOU SELECT (TO THE NEXT LARGER FOOT).
2. ADD THE FRAME PREPARATION CHARGES FOR ANY OPTIONS REQUIRED.

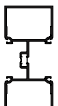
TRIFAB® VG 451T FRAMING SYSTEM (2" X 4½" CENTER)



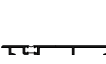

SCREW SPLINE

								
	MULLION	HEAD	HORIZONTAL ⁽⁴⁾	SILL/JAMB ⁽⁵⁾	EXPANSION MULLION	TRANSOM HEAD	THERMAL SILL FLASHING	THERMAL HP SILL FLASHING
PART NO.	4529111	4529112	4529119	4529114	4529115	4529118	4529147	4529148
#17 GRP	\$25.06	\$19.75	\$22.14	\$19.22	\$28.67	\$19.20	\$ 9.45	\$11.53
#40 GRP	26.38	20.79	23.31	20.23	30.18	20.22	10.35	11.74
#29 GRP	29.55	23.28	26.11	22.66	33.80	22.64	11.20	12.53

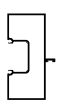

SHEAR BLOCK

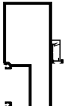
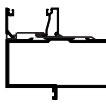
								
	MULLION	HEAD	HORIZONTAL ⁽⁴⁾	SILL/JAMB ⁽⁵⁾	EXPANSION MULLION	TRANSOM HEAD	THERMAL SILL FLASHING	THERMAL HP SILL FLASHING
PART NO.	4529117	4529112	4529119	4529114	4529115	4529114	4529147	4529148
#17 GRP	\$18.44	\$19.75	\$22.14	\$19.22	\$28.67	\$19.22	\$ 9.45	\$11.53
#40 GRP	19.91	20.79	23.31	20.23	30.18	20.23	10.35	11.74
#29 GRP	21.74	23.28	26.11	22.66	33.80	22.66	11.20	12.53

SPECIAL MOLDINGS

								
	DOOR JAMB ⁽¹⁾⁽³⁾ (NON-THERMAL)	HEADER/ T-BAR ⁽¹⁾⁽³⁾⁽⁶⁾ (NON-THERMAL)	FRONT/BACK DOOR JAMB ⁽¹⁾⁽²⁾⁽³⁾	FRONT/BACK T-BAR ⁽¹⁾⁽²⁾⁽³⁾⁽⁵⁾	STD. 4" THRESHOLD 10 (MILL)	OPTIONAL 6¾" THRESHOLD 10 (MILL)		
PART NO.	4519120	4519121	4519170	4519171	4509145	4509146		
#17 GRP	\$16.94	\$22.52	\$21.22	\$27.15	\$4.36	\$10.02		
#40 GRP	17.83	23.70	22.28	28.51	4.36	10.02		
#29 GRP	19.97	26.54	23.77	30.41	4.36	10.02		

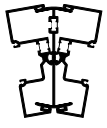
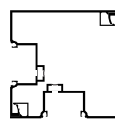
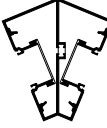
SPECIAL MOLDINGS

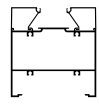
								
	0-25° CORNER	90° CORNER	135° CORNER	MULL. HALF FOR VAR. CORNER	4½" X 4½" SIDELIGHT BASE ⁽⁵⁾ (NON-THERMAL)			
PART NO.	4529122	4529123	4529124	4529125	4519126			
#17 GRP	\$38.37	\$37.28	\$37.05	\$16.45	\$32.79			
#40 GRP	40.39	39.24	39.00	17.32	34.52			
#29 GRP	45.24	43.95	43.68	19.40	38.66			

- (1) NON-THERMAL DOOR JAMBS AND T-BARS ARE THE STANDARD APPLICATION FOR IMMEDIATE DOOR FRAMES.
- (2) SPECIFY FRONT OR BACK GLASS PLANE WHEN ORDERING.
- (3) SPECIFY S/A OR D/A WHEN ORDERING.
- (4) TO SUBSTITUTE SILICONE SETTING BLOCKS, USE PART NUMBER 138016, AND ADD \$1.00 PER FOOT.
- (5) TO SUBSTITUTE SILICONE SETTING BLOCKS, USE PART NUMBER 138017, AND ADD \$3.00 PER FOOT.
- (6) TO SUBSTITUTE SILICONE SETTING BLOCKS, USE PART NUMBER 138018, AND ADD \$4.40 PER FOOT.

EC-97912-05

ENCORE® DOOR FRAMES (1¼" X 4½" AND 1¼" X 6"),
1600 WALL SYSTEM® DOOR FRAME ADAPTORS

PRICE INCLUDES:

1. FABRICATION OF SPECIAL FRAMES (DOOR FRAMING/SIDELIGHTS/FIXED AREAS, ETC.).
2. APPLICABLE GLASS STOPS.
3. GLAZING GASKETS.
4. FRAME CLIPS & SCREWS (JOINT CHARGES INCLUDED).
5. FRAMING IS FACTORY FABRICATED AND SHIPPED K.D.

NOT INCLUDED:







1. PERIMETER FASTENERS OR PREPARATION.
2. PERIMETER RECEPTORS OR SILL FLASHING.
3. BRAKES OR SPECIAL FILLERS.
4. SASH OR SASH ATTACHMENT.
5. ASSEMBLY OF FRAME.

PRICING NOTES:

1. DETERMINE THE TOTAL LINEAR FEET OF FRAMING REQUIRED AND MULTIPLY BY THE LINEAR PER FOOT CHARGE OF THE FRAMING MEMBERS YOU SELECT (TO THE NEXT LARGER FOOT).
2. ADD THE FRAME PREPARATION CHARGES FOR ANY OPTIONS REQUIRED.





EnCORE® DOOR FRAMES⁽¹⁾ (1¼" X 4½") SPECIFY FRONT GLAZE OR CENTER GLAZE SYSTEM, AND GLAZING THICKNESS AT ORDERING TIME.

SPECIAL MOLDINGS

								
	DOOR JAMB⁽²⁾⁽⁴⁾ (1-PIECE)	DOOR JAMB⁽⁴⁾ (MULLION W/ADAPTOR)	HEADER/T-BAR⁽⁴⁾⁽⁵⁾	HEAD	STD. 4" THRESHOLD 10 (MILL)	OPTIONAL 6¾" THRESHOLD 10 (MILL)		
PART NO.	150450	150451	150452	150453	4509145	4509146		
#17 GRP	\$19.38	\$23.79	\$21.88	\$17.79	\$4.36	\$10.02		
#40 GRP	20.40	25.04	23.03	18.73	4.36	10.02		
#29 GRP	22.85	28.04	25.79	20.98	4.36	10.02		

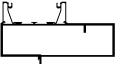







EnCORE® DOOR FRAMES⁽¹⁾ (1¼" X 6") SPECIFY GLAZING THICKNESS AT ORDERING TIME.

SPECIAL MOLDINGS

							
	DOOR JAMB⁽⁴⁾ (MULLION W/ADAPTOR)	HEADER/T-BAR⁽⁴⁾⁽⁵⁾	HEAD	STD. 4" THRESHOLD 10 (MILL)	OPTIONAL 6¾" THRESHOLD 10 (MILL)		
PART NO.	150455	150456	150457	4509145	4509146		
#17 GRP	\$25.70	\$25.01	\$17.04	\$4.36	\$10.02		
#40 GRP	27.05	26.33	17.94	4.36	10.02		
#29 GRP	30.30	29.49	20.09	4.36	10.02		

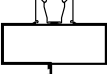
1600 WALL SYSTEM® DOOR FRAMES SPECIFY GLAZING THICKNESS AT ORDERING TIME.

SPECIAL MOLDINGS

								
	1600 SYS 1	1600 SYS 1	1600 SYS 1	1600 SYS 1	1600 SYS 1			1600 LR
	DOOR JAMB/HEADER/T-BAR⁽³⁾⁽⁴⁾ (FLUSH ADAPTOR)	DOOR JAMB/HEADER/T-BAR⁽³⁾ (FLUSH ADAPTOR) – USE W/SA STD. DOOR	DOOR HEADER⁽³⁾⁽⁴⁾⁽⁶⁾ (162038 DOOR TRANSOM – USE W/162810)	DOOR JAMB⁽⁴⁾ (¾" NON-FLUSH VERTICAL ADAPTOR)	DOOR HEADER⁽³⁾⁽⁴⁾ (TF450 DOOR TRANSOM – USE W/162811)	STD. 4" THRESHOLD 10 (MILL)	OPTIONAL 6¾" THRESHOLD 10 (MILL)	DOOR JAMB⁽⁴⁾ (7/8" NON-FLUSH VERTICAL ADAPTOR)
PART NO.	162810	162813	162812	162811	4509121	4509145	4509146	168811
#17 GRP	\$12.43	\$12.43	\$26.39	\$17.41	\$22.25	\$4.36	\$10.02	\$18.28
#40 GRP	13.08	13.08	27.78	18.33	23.42	4.36	10.02	19.17
#29 GRP	14.65	14.65	31.11	20.53	26.23	4.36	10.02	21.46

(1) ENCORE ¼" GLAZED DOOR FRAMES UTILIZE 1" VERSION WITH ADAPTORS.
 (2) ONE-PIECE DOOR JAMBS ARE THE STANDARD APPLICATION FOR IMMEDIATE DOOR FRAMES.
 (3) FOR LCN OR SURFACE CLOSERS ONLY.
 (4) SPECIFY S/A OR D/A WHEN ORDERING.
 (5) TO SUBSTITUTE SILICONE SETTING BLOCKS, USE PART NUMBER 138019, AND ADD \$2.30 PER FOOT.
 (6) TO SUBSTITUTE SILICONE SETTING BLOCKS, USE PART NUMBER 138020, AND ADD \$1.45 PER FOOT.

Laws and building and safety codes governing the design and use of glazed entrance, window, and curtain wall products vary widely. Kawneer does not control the selection of product configurations, operating hardware, or glazing materials, and assumes no responsibility therefor.

Kawneer reserves the right to change configuration without prior notice when deemed necessary for product improvement.

© Kawneer Company, Inc., 2009

CENTER HUNG TRANSOM/HEADER & THRESHOLD PACKAGES

EC-97912-05

PRICE INCLUDES:

1. FABRICATED TRANSOM BAR/HEADER.
2. MOUNTING TRAY.
3. GLASS STOP.
4. WEATHERING.
5. THRESHOLD.
6. FRAME AND CLOSER MOUNTING CLIPS.
7. SCREWS.

NOTE: SELECT CLOSER FROM PAGE A3/4.

FOR CALIBRE® INTERNATIONAL CLOSERS

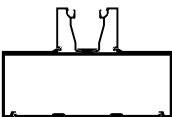
		3'0" SINGLES			6'0" PAIRS		
		TRIFAB® 400	TRIFAB® VG 450	TRIFAB® VG 451	TRIFAB® 400	TRIFAB® VG 450	TRIFAB® VG 451
 <p>HEADER PACKAGE FOR CENTER HUNG DOORS</p>	PART NO.	400644	450644	451644	400648	450648	451648
	#17 GRP	\$174.00	\$184.00	\$191.00	\$242.00	\$255.00	\$266.00
	#40 GRP	183.00	193.00	201.00	254.00	268.00	279.00
	#29 GRP	205.00	217.00	226.00	285.00	301.00	313.00
 <p>TRANSOM BAR PACKAGE FOR CENTER HUNG DOORS</p>	PART NO.	400645	450645	451645	400649	450649	451649
	#17 GRP	\$178.00	\$188.00	\$195.00	\$248.00	\$262.00	\$272.00
	#40 GRP	187.00	197.00	205.00	261.00	275.00	286.00
	#29 GRP	210.00	221.00	230.00	293.00	308.00	321.00

NOTES:

1. NOT FOR USE WITH FINGER GUARDS.

SPECIAL SIZE CHARGE:

1. NO CHARGE – FOR SINGLE TRANSOM/HEADER PACKAGES UNDER 3'0", PART NUMBER 150650 (NO CHARGE).
2. ADD – FOR SINGLE TRANSOM/HEADER PACKAGES OVER 3'0" UP TO 4'0", PART NUMBER 150651 \$22.00.
3. ADD – FOR PAIRS TRANSOM/HEADER PACKAGES OVER 6'0", PART NUMBER 150652 \$45.00.

PREP CHARGE:

1. TO PREP FOR CONCEALED ROD EXIT DEVICE, USE PART NUMBER 138651 AND ADD \$35.00.
2. TO PREP FOR CONTROLLER, USE PART NUMBER 138117 AND ADD \$30.00.
3. TO PREP FOR 3-POINT LOCK, USE PART NUMBER 138133 AND ADD \$30.00.

OPTIONAL:

1. DELETE THRESHOLD, USE PART NUMBER 031100 AND DELETE \$(21.00) SINGLE.
2. DELETE THRESHOLD, USE PART NUMBER 031101 AND DELETE \$(38.00) PAIR.
3. TO SUBSTITUTE SILICONE SETTING BLOCKS, USE PART NUMBER 138018, AND ADD \$4.40.

Laws and building and safety codes governing the design and use of glazed entrance, window, and curtain wall products vary widely. Kawneer does not control the selection of product configurations, operating hardware, or glazing materials, and assumes no responsibility therefor.

Kawneer reserves the right to change configuration without prior notice when deemed necessary for product improvement.

© Kawneer Company, Inc., 2009

EC-97912-05

S/A OFFSET ARM TRANSOM / HEADER & THRESHOLD PACKAGES

PRICE INCLUDES:

1. FABRICATED TRANSOM BAR/HEADER.
2. MOUNTING TRAY.
3. GLASS STOP.
4. WEATHERING.
5. THRESHOLD.
6. FRAME AND CLOSER MOUNTING CLIPS.
7. SCREWS.

NOTE: SELECT CLOSER FROM PAGE A3/4 AND ARM PACKAGE FROM PAGE A3/5.**FOR S/A OFFSET ARM CLOSERS**

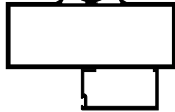
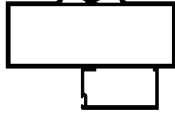
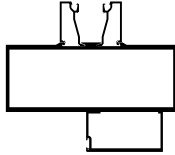
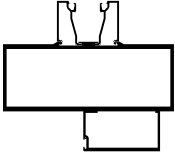
		3'0" SINGLES			6'0" PAIRS		
		TRIFAB® 400	TRIFAB® VG 450	TRIFAB® VG 451	TRIFAB® 400	TRIFAB® VG 450	TRIFAB® VG 451
 OFFSET PIVOT HEADER PACKAGE	PART NO.	400650 R.H. 400651 L.H.	450650 R.H. 450651 L.H.	451650 R.H. 451651 L.H.	400654	450654	451654
	#17 GRP	\$227.00	\$240.00	\$248.00	\$295.00	\$311.00	\$323.00
	#40 GRP	238.00	251.00	261.00	310.00	327.00	340.00
	#29 GRP	267.00	282.00	293.00	375.00	367.00	381.00
 BUTT HUNG HEADER PACKAGE	PART NO.	400660 R.H. 400661 L.H.	450660 R.H. 450661 L.H.	451660 R.H. 451661 L.H.	400664	450664	451664
	#17 GRP	\$230.00	\$243.00	\$253.00	\$300.00	\$315.00	\$328.00
	#40 GRP	242.00	255.00	266.00	314.00	331.00	345.00
	#29 GRP	272.00	286.00	298.00	352.00	371.00	387.00
 OFFSET PIVOT TRANSOM BAR PACKAGE	PART NO.	400655 R.H. 400656 L.H.	450655 R.H. 450656 L.H.	451655 R.H. 451656 L.H.	400659	450659	451659
	#17 GRP	\$230.00	\$243.00	\$253.00	\$300.00	\$315.00	\$328.00
	#40 GRP	242.00	255.00	266.00	316.00	333.00	347.00
	#29 GRP	272.00	286.00	298.00	352.00	371.00	387.00
 BUTT HUNG TRANSOM BAR PACKAGE	PART NO.	400665 R.H. 400666 L.H.	450665 R.H. 450666 L.H.	451665 R.H. 451666 L.H.	400669	450669	451669
	#17 GRP	\$234.00	\$247.00	\$266.00	\$304.00	\$321.00	\$334.00
	#40 GRP	246.00	260.00	270.00	320.00	338.00	351.00
	#29 GRP	276.00	292.00	303.00	359.00	379.00	394.00

PECIAL SIZE CHARGE:

1. NO CHARGE – FOR SINGLE TRANSOM/HEADER PACKAGES UNDER 3'0", PART NUMBER 150656 **(NO CHARGE)**.
2. ADD – FOR SINGLE TRANSOM/HEADER PACKAGES OVER 3'0" UP TO 4'0", PART NUMBER 150657 **\$22.00**.
3. ADD – FOR PAIRS TRANSOM/HEADER PACKAGES OVER 6'0", PART NUMBER 150658 **\$45.00**.

PREP CHARGE:

1. TO PREP FOR CONCEALED ROD EXIT DEVICE, USE PART NUMBER 138651 AND ADD **\$35.00**.
2. TO PREP FOR CONTROLLER, USE PART NUMBER 138117 AND ADD **\$30.00**.
3. TO PREP FOR 3-POINT LOCK, USE PART NUMBER 138133 AND ADD **\$30.00**.

OPTIONAL:

1. DELETE THRESHOLD, USE PART NUMBER 031100 AND DELETE **\$(21.00)** SINGLE.
2. DELETE THRESHOLD, USE PART NUMBER 031101 AND DELETE **\$(38.00)** PAIR.
3. TO SUBSTITUTE SILICONE SETTING BLOCKS, USE PART NUMBER 138018, AND ADD **\$4.40**.

HINGING HARDWARE

EC-97912-05

NOTE:

1. ALL PRICES ARE PER ITEM.
2. PART NUMBERS DO NOT IMPLY HARDWARE/DOOR/FRAME COMPATIBILITY.
3. VERIFY ALL HARDWARE APPLICATIONS AND COMBINATIONS WITH AN APPROPRIATE HARDWARE CONSULTANT.
4. WHEN HARDWARE NEEDS TO BE APPLIED TO BOTH DOOR AND FRAME, THE HARDWARE WILL TYPICALLY BE APPLIED TO AND SHIPPED WITH THE DOOR.

BUTT HINGES (PER HINGE)

	PART NO.	PRICE
STANDARD 4½" X 4" TEMPLATE BUTT HINGE		
COMPLETE DOOR/FRAME FABRICATION AND APPLICATION	139001	\$106.00
FABRICATION FOR DOOR	139001DP	42.00
FABRICATION FOR FRAME	139001FP	42.00
HARDWARE APPLICATION	139001HA	22.00
ALL OTHER BUTT HINGES		
COMPLETE DOOR/FRAME FABRICATION AND APPLICATION	139002	148.00
FABRICATION FOR DOOR	139002DP	63.00
FABRICATION FOR FRAME	139002FP	63.00
HARDWARE APPLICATION	139002HA	22.00
ANCHOR HINGE		
COMPLETE DOOR/FRAME FABRICATION AND APPLICATION	139003	336.00
FABRICATION FOR DOOR	139003DP	125.00
FABRICATION FOR FRAME	139003FP	167.00
HARDWARE APPLICATION	139003HA	44.00

CONTINUOUS HINGE

UP TO 8'-0" DOOR		
COMPLETE DOOR/FRAME FABRICATION AND APPLICATION	139004	200.00
FABRICATION FOR DOOR	139004DP	75.00
FABRICATION FOR FRAME	139004FP	75.00
HARDWARE APPLICATION	139004HA	50.00

Laws and building and safety codes governing the design and use of glazed entrance, window, and curtain wall products vary widely. Kawneer does not control the selection of product configurations, operating hardware, or glazing materials, and assumes no responsibility therefor.

Kawneer reserves the right to change configuration without prior notice when deemed necessary for product improvement.

© Kawneer Company, Inc., 2009

EC-97912-05

PIVOTING HARDWARE

NOTE:

1. ALL PRICES ARE **PER ITEM**.
2. PART NUMBERS DO NOT IMPLY HARDWARE/DOOR/FRAME COMPATIBILITY.
3. VERIFY ALL HARDWARE APPLICATIONS AND COMBINATIONS WITH AN APPROPRIATE HARDWARE CONSULTANT.
4. WHEN HARDWARE NEEDS TO BE APPLIED TO BOTH DOOR AND FRAME, THE HARDWARE WILL TYPICALLY BE APPLIED TO AND SHIPPED WITH THE DOOR.

OFFSET PIVOTS

TOP OFFSET PIVOT	PART NO.	PRICE
COMPLETE DOOR/FRAME FABRICATION AND APPLICATION	139005	\$117.00
FABRICATION FOR DOOR	139005DP	54.00
FABRICATION FOR FRAME	139005FP	54.00
HARDWARE APPLICATION	139005HA	9.00
INTERMEDIATE PIVOT		
COMPLETE DOOR/FRAME FABRICATION AND APPLICATION	139006	252.00
FABRICATION FOR DOOR	139006DP	115.00
FABRICATION FOR FRAME	139006FP	115.00
HARDWARE APPLICATION	139006HA	22.00
BOTTOM OFFSET PIVOT		
COMPLETE DOOR/FRAME FABRICATION AND APPLICATION	139007	254.00
FABRICATION FOR DOOR	139007DP	104.00
FABRICATION FOR FRAME	139007FP	83.00
HARDWARE APPLICATION	139007HA	67.00

CENTER PIVOTS

WALKING BEAM PIVOT		
COMPLETE DOOR/FRAME FABRICATION AND APPLICATION	139008	204.00
FABRICATION FOR DOOR	139008DP	42.00
FABRICATION FOR FRAME	139008FP	140.00
HARDWARE APPLICATION	139008HA	22.00
BOTTOM CENTER PIVOT		
COMPLETE DOOR/FRAME FABRICATION AND APPLICATION	139009	66.00
FABRICATION FOR DOOR	139009DP	42.00
FABRICATION FOR FRAME	139009FP	15.00
HARDWARE APPLICATION	139009HA	9.00

Laws and building and safety codes governing the design and use of glazed entrance, window, and curtain wall products vary widely. Kawneer does not control the selection of product configurations, operating hardware, or glazing materials, and assumes no responsibility therefor.

Kawneer reserves the right to change configuration without prior notice when deemed necessary for product improvement.

© Kawneer Company, Inc., 2009

LOCKING HARDWARE

EC-97912-05

NOTE:

1. ALL PRICES ARE **PER ITEM**.
2. PART NUMBERS DO NOT IMPLY HARDWARE/DOOR/FRAME COMPATIBILITY.
3. VERIFY ALL HARDWARE APPLICATIONS AND COMBINATIONS WITH AN APPROPRIATE HARDWARE CONSULTANT.
4. WHEN HARDWARE NEEDS TO BE APPLIED TO BOTH DOOR AND FRAME, THE HARDWARE WILL TYPICALLY BE APPLIED TO AND SHIPPED WITH THE DOOR.

LOCKING

	PART NO.	PRICE
DEADLOCK ON SINGLE DOOR		
COMPLETE DOOR/FRAME FABRICATION AND APPLICATION	139051	\$ 98.00
FABRICATION FOR DOOR	139051DP	42.00
FABRICATION FOR FRAME	139051FP	25.00
HARDWARE APPLICATION	139051HA	31.00
DEADLOCK ON PAIR OF DOORS		
COMPLETE DOOR/FRAME FABRICATION AND APPLICATION	139052	98.00
FABRICATION FOR DOOR	139052DP	67.00
FABRICATION FOR FRAME	N/A	—
HARDWARE APPLICATION	139052HA	31.00
DEADLOCK WITH 3-POINT LOCK		
COMPLETE DOOR/FRAME FABRICATION AND APPLICATION	139053	172.00
FABRICATION FOR DOOR	139053DP	63.00
FABRICATION FOR FRAME	139053FP	42.00
HARDWARE APPLICATION	139053HA	67.00
EXIT INDICATOR		
COMPLETE DOOR/FRAME FABRICATION AND APPLICATION	139054	30.00
FABRICATION FOR DOOR	139054DP	21.00
FABRICATION FOR FRAME	N/A	—
HARDWARE APPLICATION	139054HA	9.00
CYLINDER GUARD		
COMPLETE DOOR/FRAME FABRICATION AND APPLICATION	139055	17.00
FABRICATION FOR DOOR	139055DP	13.00
FABRICATION FOR FRAME	N/A	—
HARDWARE APPLICATION	139055HA	4.00
ARMORED STRIKE ON SINGLE DOOR (DOES NOT INCLUDE APPROPRIATE DEADLOCK PREP)		
COMPLETE DOOR/FRAME FABRICATION AND APPLICATION	139056	22.00
FABRICATION FOR DOOR	N/A	—
FABRICATION FOR FRAME	139056FP	13.00
HARDWARE APPLICATION	139056HA	9.00
ARMORED STRIKE ON PAIR OF DOORS (DOES NOT INCLUDE APPROPRIATE DEADLOCK PREP)		
COMPLETE DOOR/FRAME FABRICATION AND APPLICATION	139057	22.00
FABRICATION FOR DOOR	139057DP	13.00
FABRICATION FOR FRAME	N/A	—
HARDWARE APPLICATION	139057HA	9.00

Laws and building and safety codes governing the design and use of glazed entrance, window, and curtain wall products vary widely. Kawneer does not control the selection of product configurations, operating hardware, or glazing materials, and assumes no responsibility therefor.

Kawneer reserves the right to change configuration without prior notice when deemed necessary for product improvement.

© Kawneer Company, Inc., 2009

EC-97912-05

LOCKING HARDWARE

NOTE:

1. ALL PRICES ARE **PER ITEM**.
2. PART NUMBERS DO NOT IMPLY HARDWARE/DOOR/FRAME COMPATIBILITY.
3. VERIFY ALL HARDWARE APPLICATIONS AND COMBINATIONS WITH AN APPROPRIATE HARDWARE CONSULTANT.
4. WHEN HARDWARE NEEDS TO BE APPLIED TO BOTH DOOR AND FRAME, THE HARDWARE WILL TYPICALLY BE APPLIED TO AND SHIPPED WITH THE DOOR.

LATCH LOCKS

	PART NO.	PRICE
MS + 1890 LATCH LOCK ON SINGLE DOOR		
COMPLETE DOOR/FRAME FABRICATION AND APPLICATION	139058	\$184.00
FABRICATION FOR DOOR	139058DP	42.00
FABRICATION FOR FRAME	139058FP	75.00
HARDWARE APPLICATION	139058HA	67.00
MS + 1890 LATCH LOCK ON PAIR OF DOORS		
COMPLETE DOOR/FRAME FABRICATION AND APPLICATION	139059	184.00
FABRICATION FOR DOOR	139059DP	117.00
FABRICATION FOR FRAME	N/A	—
HARDWARE APPLICATION	139059HA	67.00
LATCH LOCK ON SINGLE DOOR (LEVER OR PADDLE)		
COMPLETE DOOR/FRAME FABRICATION AND APPLICATION	139060	154.00
FABRICATION FOR DOOR	139060DP	42.00
FABRICATION FOR FRAME	139060FP	45.00
HARDWARE APPLICATION	139060HA	67.00
LATCH LOCK ON PAIR OF DOORS (LEVER OR PADDLE)		
COMPLETE DOOR/FRAME FABRICATION AND APPLICATION	139061	154.00
FABRICATION FOR DOOR	139061DP	87.00
FABRICATION FOR FRAME	N/A	—
HARDWARE APPLICATION	139061HA	67.00

Laws and building and safety codes governing the design and use of glazed entrance, window, and curtain wall products vary widely. Kawneer does not control the selection of product configurations, operating hardware, or glazing materials, and assumes no responsibility therefor.

Kawneer reserves the right to change configuration without prior notice when deemed necessary for product improvement.

© Kawneer Company, Inc., 2009

LOCKING HARDWARE

EC-97912-05

NOTE:

1. ALL PRICES ARE PER ITEM.
2. PART NUMBERS DO NOT IMPLY HARDWARE/DOOR/FRAME COMPATIBILITY.
3. VERIFY ALL HARDWARE APPLICATIONS AND COMBINATIONS WITH AN APPROPRIATE HARDWARE CONSULTANT.
4. WHEN HARDWARE NEEDS TO BE APPLIED TO BOTH DOOR AND FRAME, THE HARDWARE WILL TYPICALLY BE APPLIED TO AND SHIPPED WITH THE DOOR.

MISCELLANEOUS LOCKS

	PART NO.	PRICE
MS 1870 CYLINDER OPERATED FLUSH BOLT		
COMPLETE DOOR/FRAME FABRICATION AND APPLICATION	139062	\$139.00
FABRICATION FOR DOOR	139062DP	42.00
FABRICATION FOR FRAME	139062FP	30.00
HARDWARE APPLICATION	139062HA	67.00
MS 1880 TWO POINT LOCK		
COMPLETE DOOR/FRAME FABRICATION AND APPLICATION	139063	124.00
FABRICATION FOR DOOR	139063DP	50.00
FABRICATION FOR FRAME	139063FP	30.00
HARDWARE APPLICATION	139063HA	44.00
BOTTOM RAIL LOCK		
COMPLETE DOOR/FRAME FABRICATION AND APPLICATION	139064	252.00
FABRICATION FOR DOOR	139064DP	188.00
FABRICATION FOR FRAME	139064FP	42.00
HARDWARE APPLICATION	139064HA	22.00

CYLINDRICAL LOCKS

CYLINDRICAL LOCK SET ON SINGLE DOOR (BORED OR MORTISE)		
COMPLETE DOOR/FRAME FABRICATION AND APPLICATION	139065	215.00
FABRICATION FOR DOOR	139065DP	83.00
FABRICATION FOR FRAME	139065FP	21.00
HARDWARE APPLICATION	139065HA	111.00
CYLINDRICAL LOCK SET ON PAIR OF DOORS (BORED OR MORTISE)		
COMPLETE DOOR/FRAME FABRICATION AND APPLICATION	139066	215.00
FABRICATION FOR DOOR	139066DP	104.00
FABRICATION FOR FRAME	N/A	—
HARDWARE APPLICATION	139066HA	111.00

Laws and building and safety codes governing the design and use of glazed entrance, window, and curtain wall products vary widely. Kawneer does not control the selection of product configurations, operating hardware, or glazing materials, and assumes no responsibility therefor.

Kawneer reserves the right to change configuration without prior notice when deemed necessary for product improvement.

© Kawneer Company, Inc., 2009

Laws and building and safety codes governing the design and use of glazed entrance, window, and curtain wall products vary widely. Kawneer does not control the selection of product configurations, operating hardware, or glazing materials, and assumes no responsibility therefor.

**THIS PAGE LEFT
INTENTIONALLY
BLANK**

Kawneer reserves the right to change configuration without prior notice when deemed necessary for product improvement.

© Kawneer Company, Inc., 2009

EXIT DEVICE HARDWARE

EC-97912-05

NOTES:

1. ALL PRICES ARE PER ITEM.
2. PRICES DO NOT INCLUDE EXIT DEVICE TRIM PREP. PICK UP APPROPRIATE EXIT DEVICE TRIM PREP FROM PAGE A2/39.
3. PART NUMBERS DO NOT IMPLY HARDWARE/DOOR/FRAME COMPATIBILITY.
4. VERIFY ALL HARDWARE APPLICATIONS AND COMBINATIONS WITH AN APPROPRIATE HARDWARE CONSULTANT.
5. WHEN HARDWARE NEEDS TO BE APPLIED TO BOTH DOOR AND FRAME, THE HARDWARE WILL TYPICALLY BE APPLIED TO AND SHIPPED WITH THE DOOR.

CONCEALED EXIT DEVICE		
	PART NO.	PRICE
DOR-O-MATIC CONCEALED ROD EXIT DEVICE		
COMPLETE DOOR/FRAME FABRICATION AND APPLICATION	139101	\$300.00
FABRICATION FOR DOOR	139101DP	125.00
FABRICATION FOR FRAME	139101FP	42.00
HARDWARE APPLICATION	139101HA	133.00
VON DUPRIN CONCEALED ROD EXIT DEVICE		
COMPLETE DOOR/FRAME FABRICATION AND APPLICATION	139102	429.00
FABRICATION FOR DOOR	139102DP	188.00
FABRICATION FOR FRAME	139102FP	63.00
HARDWARE APPLICATION	139102HA	178.00
ALL OTHER CONCEALED ROD EXIT DEVICE		
COMPLETE DOOR/FRAME FABRICATION AND APPLICATION	139103	641.00
FABRICATION FOR DOOR	139103DP	250.00
FABRICATION FOR FRAME	139103FP	125.00
HARDWARE APPLICATION	139103HA	266.00
RIM EXIT DEVICE		
ALL RIM EXIT DEVICES		
COMPLETE DOOR/FRAME FABRICATION AND APPLICATION	139104	297.00
FABRICATION FOR DOOR	139104DP	125.00
FABRICATION FOR FRAME	139104FP	83.00
HARDWARE APPLICATION	139104HA	89.00
MORTISE EXIT DEVICE		
ALL MORTISE EXIT DEVICES		
COMPLETE DOOR/FRAME FABRICATION AND APPLICATION	139105	491.00
FABRICATION FOR DOOR	139105DP	250.00
FABRICATION FOR FRAME	139105FP	63.00
HARDWARE APPLICATION	139105HA	178.00
SURFACE ROD EXIT DEVICE		
ALL SURFACE ROD EXIT DEVICES		
COMPLETE DOOR/FRAME FABRICATION AND APPLICATION	139106	533.00
FABRICATION FOR DOOR	139106DP	292.00
FABRICATION FOR FRAME	139106FP	63.00
HARDWARE APPLICATION	139106HA	178.00
REMOVABLE MULLION		
REMOVABLE MULLION		
COMPLETE DOOR/FRAME FABRICATION AND APPLICATION	N/A	—
FABRICATION FOR DOOR	N/A	—
FABRICATION FOR FRAME (SHIP LOOSE ONLY)	139107FP	200.00
HARDWARE APPLICATION	N/A	—

Laws and building and safety codes governing the design and use of glazed entrance, window, and curtain wall products vary widely. Kawneer does not control the selection of product configurations, operating hardware, or glazing materials, and assumes no responsibility therefor.

Kawneer reserves the right to change configuration without prior notice when deemed necessary for product improvement.

© Kawneer Company, Inc., 2009

EC-97912-05

EXIT DEVICE HARDWARE

NOTES:

1. ALL PRICES ARE PER ITEM.
2. PRICES DO NOT INCLUDE EXIT DEVICE TRIM PREP. PICK UP APPROPRIATE EXIT DEVICE TRIM PREP FROM PAGE A2/38.
3. PART NUMBERS DO NOT IMPLY HARDWARE/DOOR/FRAME COMPATIBILITY.
4. VERIFY ALL HARDWARE APPLICATIONS AND COMBINATIONS WITH AN APPROPRIATE HARDWARE CONSULTANT.
5. WHEN HARDWARE NEEDS TO BE APPLIED TO BOTH DOOR AND FRAME, THE HARDWARE WILL TYPICALLY BE APPLIED TO AND SHIPPED WITH THE DOOR.

EXIT DEVICE TRIMS

	PART NO.	PRICE
DOR-O-MATIC		
COMPLETE DOOR/FRAME FABRICATION AND APPLICATION	139108	\$ 47.00
FABRICATION FOR DOOR	139108DP	25.00
FABRICATION FOR FRAME	N/A	—
HARDWARE APPLICATION	139108HA	22.00
VON DUPRIN		
COMPLETE DOOR/FRAME FABRICATION AND APPLICATION	139109	55.00
FABRICATION FOR DOOR	139109DP	33.00
FABRICATION FOR FRAME	N/A	—
HARDWARE APPLICATION	139109HA	22.00
ADAMS RITE		
COMPLETE DOOR/FRAME FABRICATION AND APPLICATION	139110	47.00
FABRICATION FOR DOOR	139110DP	25.00
FABRICATION FOR FRAME	N/A	—
HARDWARE APPLICATION	139110HA	22.00
CORBIN/RUSSWIN		
COMPLETE DOOR/FRAME FABRICATION AND APPLICATION	139111	81.00
FABRICATION FOR DOOR	139111DP	50.00
FABRICATION FOR FRAME	N/A	—
HARDWARE APPLICATION	139111HA	31.00
JACKSON/INTERNATIONAL		
COMPLETE DOOR/FRAME FABRICATION AND APPLICATION	139112	43.00
FABRICATION FOR DOOR	139112DP	21.00
FABRICATION FOR FRAME	N/A	—
HARDWARE APPLICATION	139112HA	22.00
PRECISION		
COMPLETE DOOR/FRAME FABRICATION AND APPLICATION	139113	47.00
FABRICATION FOR DOOR	139113DP	25.00
FABRICATION FOR FRAME	N/A	—
HARDWARE APPLICATION	139113HA	22.00
SARGENT		
COMPLETE DOOR/FRAME FABRICATION AND APPLICATION	139114	81.00
FABRICATION FOR DOOR	139114DP	50.00
FABRICATION FOR FRAME	N/A	—
HARDWARE APPLICATION	139114HA	31.00
ALL OTHERS		
COMPLETE DOOR/FRAME FABRICATION AND APPLICATION	139115	142.00
FABRICATION FOR DOOR	139115DP	75.00
FABRICATION FOR FRAME	N/A	—
HARDWARE APPLICATION	139115HA	67.00

Laws and building and safety codes governing the design and use of glazed entrance, window, and curtain wall products vary widely. Kawneer does not control the selection of product configurations, operating hardware, or glazing materials, and assumes no responsibility therefor.

Kawneer reserves the right to change configuration without prior notice when deemed necessary for product improvement.

© Kawneer Company, Inc., 2009

CLOSERS AND DOOR HOLDERS

EC-97912-05

NOTES:

1. ALL PRICES ARE PER ITEM.
2. PART NUMBERS DO NOT IMPLY HARDWARE/DOOR/FRAME COMPATIBILITY.
3. VERIFY ALL HARDWARE APPLICATIONS AND COMBINATIONS WITH AN APPROPRIATE HARDWARE CONSULTANT.
4. WHEN HARDWARE NEEDS TO BE APPLIED TO BOTH DOOR AND FRAME, THE HARDWARE WILL TYPICALLY BE APPLIED TO AND SHIPPED WITH THE DOOR.

CONCEALED EXIT DEVICE (DOES NOT INCLUDE HINGING PREP, MAY REQUIRE A SPECIAL TOP RAIL AND AFFECT GLASS)

	PART NO.	PRICE
CENTER HUNG CLOSER PREP		
COMPLETE DOOR/FRAME FABRICATION AND APPLICATION	139010	\$122.00
FABRICATION FOR DOOR	N/A	—
FABRICATION FOR FRAME	139010FP	100.00
HARDWARE APPLICATION	139010HA	22.00
CENTER HUNG ARM PREP		
COMPLETE DOOR/FRAME FABRICATION AND APPLICATION	139011	107.00
FABRICATION FOR DOOR	139011DP	85.00
FABRICATION FOR FRAME	N/A	—
HARDWARE APPLICATION	139011HA	22.00
SINGLE ACTING CLOSER PREP		
COMPLETE DOOR/FRAME FABRICATION AND APPLICATION	139012	199.00
FABRICATION FOR DOOR	N/A	—
FABRICATION FOR FRAME	139012FP	168.00
HARDWARE APPLICATION	139012HA	31.00
SINGLE ACTING ARM PREP		
COMPLETE DOOR/FRAME FABRICATION AND APPLICATION	139013	136.00
FABRICATION FOR DOOR	139013DP	105.00
FABRICATION FOR FRAME	N/A	—
HARDWARE APPLICATION	139013HA	31.00

FLOOR CLOSERS (DOES NOT INCLUDE HINGING PREP)

CENTER HUNG CLOSER ARM FABRICATION		
COMPLETE DOOR/FRAME FABRICATION AND APPLICATION	139014	107.00
FABRICATION FOR DOOR	139014DP	85.00
FABRICATION FOR FRAME	N/A	—
HARDWARE APPLICATION	139014HA	22.00
OFFSET PIVOT CLOSER ARM FABRICATION		
COMPLETE DOOR/FRAME FABRICATION AND APPLICATION	139015	136.00
FABRICATION FOR DOOR	139015DP	105.00
FABRICATION FOR FRAME	N/A	—
HARDWARE APPLICATION	139015HA	31.00

DOOR HOLDERS (MAY REQUIRE A SPECIAL TOP RAIL AND AFFECT GLASS SIZE)

CONCEALED HOLDER		
COMPLETE DOOR/FRAME FABRICATION AND APPLICATION	139016	218.00
FABRICATION FOR DOOR	139016DP	104.00
FABRICATION FOR FRAME	139016FP	83.00
HARDWARE APPLICATION	139016HA	31.00
SURFACE HOLDER		
COMPLETE DOOR/FRAME FABRICATION AND APPLICATION	139017	184.00
FABRICATION FOR DOOR	139017DP	83.00
FABRICATION FOR FRAME	139017FP	83.00
HARDWARE APPLICATION	139017HA	18.00

Laws and building and safety codes governing the design and use of glazed entrance, window, and curtain wall products vary widely. Kawneer does not control the selection of product configurations, operating hardware, or glazing materials, and assumes no responsibility therefor.

Kawneer reserves the right to change configuration without prior notice when deemed necessary for product improvement.

© Kawneer Company, Inc., 2009

EC-97912-05

MISCELLANEOUS HARDWARE

NOTE:

1. ALL PRICES ARE **PER ITEM**.
2. PART NUMBERS DO NOT IMPLY HARDWARE/DOOR/FRAME COMPATIBILITY.
3. VERIFY ALL HARDWARE APPLICATIONS AND COMBINATIONS WITH AN APPROPRIATE HARDWARE CONSULTANT.
4. WHEN HARDWARE NEEDS TO BE APPLIED TO BOTH DOOR AND FRAME, THE HARDWARE WILL TYPICALLY BE APPLIED TO AND SHIPPED WITH THE DOOR.

MISCELLANEOUS HARDWARE		
	PART NO.	PRICE
FLUSHBOLTS (PER PAIR)		
COMPLETE DOOR/FRAME FABRICATION AND APPLICATION	139018	\$ 94.00
FABRICATION FOR DOOR	139018DP	42.00
FABRICATION FOR FRAME	139018FP	30.00
HARDWARE APPLICATION	139018HA	22.00
NON STANDARD PUSH PULL		
COMPLETE DOOR/FRAME FABRICATION AND APPLICATION	139019	44.00
FABRICATION FOR DOOR	139019DP	13.00
FABRICATION FOR FRAME	N/A	—
HARDWARE APPLICATION	139019HA	31.00
VON DUPRIN POWER TRANSFER		
COMPLETE DOOR/FRAME FABRICATION (SHIP LOOSE ONLY)	139020	134.00
FABRICATION FOR DOOR	139020DP	67.00
FABRICATION FOR FRAME	139020FP	67.00
HARDWARE APPLICATION	N/A	—
STANDARD ELECTRIC STRIKE ON SINGLE DOOR (AR 7130 / HES 7089)		
COMPLETE DOOR/FRAME FABRICATION AND APPLICATION	139021	126.00
FABRICATION FOR DOOR	N/A	—
FABRICATION FOR FRAME	139021FP	104.00
HARDWARE APPLICATION	139021HA	22.00
STANDARD ELECTRIC STRIKE ON PAIR OF DOORS (AR 7130 / HES 7089)		
COMPLETE DOOR/FRAME FABRICATION AND APPLICATION	139022	126.00
FABRICATION FOR DOOR	139022DP	104.00
FABRICATION FOR FRAME	N/A	—
HARDWARE APPLICATION	139022HA	22.00
ALL OTHER ELECTRIC STRIKES ON SINGLE DOOR		
COMPLETE DOOR/FRAME FABRICATION AND APPLICATION	139023	140.00
FABRICATION FOR DOOR	N/A	—
FABRICATION FOR FRAME	139023FP	104.00
HARDWARE APPLICATION	139023HA	36.00
ALL OTHER ELECTRIC STRIKES ON PAIR OF DOORS		
COMPLETE DOOR/FRAME FABRICATION AND APPLICATION	139024	140.00
FABRICATION FOR DOOR	139024DP	104.00
FABRICATION FOR FRAME	N/A	—
HARDWARE APPLICATION	139024HA	36.00

Laws and building and safety codes governing the design and use of glazed entrance, window, and curtain wall products vary widely. Kawneer does not control the selection of product configurations, operating hardware, or glazing materials, and assumes no responsibility therefor.

Kawneer reserves the right to change configuration without prior notice when deemed necessary for product improvement.

© Kawneer Company, Inc., 2009

MISCELLANEOUS HARDWARE

EC-97912-05

NOTE:

1. ALL PRICES ARE PER ITEM.
2. PART NUMBERS DO NOT IMPLY HARDWARE/DOOR/FRAME COMPATIBILITY.
3. VERIFY ALL HARDWARE APPLICATIONS AND COMBINATIONS WITH AN APPROPRIATE HARDWARE CONSULTANT.
4. WHEN HARDWARE NEEDS TO BE APPLIED TO BOTH DOOR AND FRAME, THE HARDWARE WILL TYPICALLY BE APPLIED TO AND SHIPPED WITH THE DOOR.

MISCELLANEOUS HARDWARE (Continued)

	PART NO.	PRICE
RIM PANIC ELECTRIC STRIKE (SINGLE DOORS ONLY)		
COMPLETE DOOR/FRAME FABRICATION AND APPLICATION	N/A	—
FABRICATION FOR DOOR	N/A	—
FABRICATION FOR FRAME (SHIP LOOSE ONLY)	139025FP	\$133.00
HARDWARE APPLICATION	N/A	—
MAGNETIC LOCK (SURFACE APPLIED – PER LEAF)		
COMPLETE DOOR/FRAME FABRICATION AND APPLICATION	139026	144.00
FABRICATION FOR DOOR	139026DP	42.00
FABRICATION FOR FRAME	139026FP	71.00
HARDWARE APPLICATION	139026HA	31.00
MAGNETIC LOCK (CONCEALED – PER LEAF)		
COMPLETE DOOR/FRAME FABRICATION AND APPLICATION	139027	357.00
FABRICATION FOR DOOR	139027DP	188.00
FABRICATION FOR FRAME	139027FP	125.00
HARDWARE APPLICATION	139027HA	44.00