

CONTENTS

SECTION C2T...TRIFAB® VG 451T

PUNCHED OPENING FABRICATION	PAGE
FRONT SET – I.G. (INSIDE GLAZED)	
CAPTURED/SSG (STRUCTURAL SILICONE GLAZE)	C2T/302
WEATHERSEAL	C2T/303
MISCELLANEOUS MOLDINGS	
CORNERS (FRONT I.G.)	C2T/304
RECEPTORS/ADAPTORS	C2T/305
ACCESSORIES	
FASTENERS/DRILL FIXTURES/SPLICE SLEEVE/SHIM BACKER	C2T/306
GLAZING ACCESSORIES	C2T/306 & 307
GASKETS	C2T/308













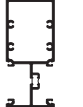

FINISH GROUPS

GROUP NO. DESIGNATION	FINISHES INCLUDED
#17 GRP	#17 CLEAR
#40 GRP	#40 BRONZE BW – BONE WHITE #22 STD. PAINT #14 CLEAR
#29 GRP	#29 BLACK #18 CHAMPAGNE #26 LIGHT BRONZE #28 MEDIUM BRONZE

Laws and building and safety codes governing the design and use of glazed entrance, window, and curtain wall products vary widely. Kawneer does not control the selection of product configurations, operating hardware, or glazing materials, and assumes no responsibility therefor.

Kawneer reserves the right to change configuration without prior notice when deemed necessary for product improvement.









© Kawneer Company, Inc., 2008

DESCRIPTION		PART NO.	FT./UNIT	FINISH	PRICE/UNIT	UNITS/PKG.
CAPTURED – FRONT SET I.G. (INSIDE GLAZE)						
SYSTEM AVAILABLE AS INSIDE GLAZE ONLY						
	HEAD	451TVG103	24'	#17 GRP	\$247.00	4
				#40 GRP	270.00	
				#29 GRP	302.00	
	GLASS STOP	451VG104	24'	#17 GRP	101.00	8
				#40 GRP	114.00	
				#29 GRP	128.00	
	HORIZONTAL	451TVG111	24'	#17 GRP	326.00	4
				#40 GRP	345.00	
				#29 GRP	382.00	
	GLASS STOP	451VG104	24'	#17 GRP	101.00	8
				#40 GRP	114.00	
				#29 GRP	128.00	
	SILL	451TVG101	24'	#17 GRP	284.00	4
				#40 GRP	310.00	
				#29 GRP	342.00	
	JAMB	451TVG101	24'	#17 GRP	284.00	4
				#40 GRP	310.00	
				#29 GRP	342.00	
	MULLION	451TVG005	24'	#17 GRP	344.00	4
				#40 GRP	365.00	
				#29 GRP	414.00	
SSG (STRUCTURAL SILICONE GLAZE) – FRONT SET I.G. (INSIDE GLAZE)						
SYSTEM AVAILABLE AS INSIDE GLAZE ONLY						
	HEAD	451TVG103	24'	#17 GRP	247.00	4
				#40 GRP	270.00	
				#29 GRP	302.00	
	GLASS STOP	451VG104	24'	#17 GRP	101.00	8
				#40 GRP	114.00	
				#29 GRP	128.00	
	HORIZONTAL	451TSSG111	24'	#17 GRP	324.00	4
				#40 GRP	342.00	
				#29 GRP	383.00	
	HORIZONTAL COVER	451SSG004	24'	#17 GRP	52.00	4
				#40 GRP	60.00	
				#29 GRP	70.00	
	GLASS STOP	451VG104	24'	#17 GRP	101.00	8
				#40 GRP	114.00	
				#29 GRP	128.00	
	SILL	451TVG101	24'	#17 GRP	284.00	4
				#40 GRP	310.00	
				#29 GRP	342.00	
	JAMB	451TVG101	24'	#17 GRP	284.00	4
				#40 GRP	310.00	
				#29 GRP	342.00	
	MULLION	451SSG005	24'	#17 GRP	306.00	3
				#40 GRP	320.00	
				#29 GRP	358.00	

Laws and building and safety codes governing the design and use of glazed entrance, window, and curtain wall products vary widely. Kawneer does not control the selection of product configurations, operating hardware, or glazing materials, and assumes no responsibility therefor.

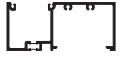
Kawneer reserves the right to change configuration without prior notice when deemed necessary for product improvement.





© Kawneer Company, Inc., 2008

DESCRIPTION		PART NO.	FT./UNIT	FINISH	PRICE/UNIT	UNITS/PKG.
WEATHERSEAL – FRONT SET I.G. (INSIDE GLAZE)						
SYSTEM AVAILABLE AS INSIDE GLAZE ONLY						
	HEAD	451TVG103	24'	#17 GRP	\$247.00	4
				#40 GRP	270.00	
				#29 GRP	302.00	
	GLASS STOP	451VG104	24'	#17 GRP	101.00	8
				#40 GRP	114.00	
				#29 GRP	128.00	
	HORIZONTAL	451TSSG111	24'	#17 GRP	324.00	4
				#40 GRP	342.00	
				#29 GRP	383.00	
	HORIZONTAL COVER	451SSG004	24'	#17 GRP	52.00	4
				#40 GRP	60.00	
				#29 GRP	70.00	
	GLASS STOP	451VG104	24'	#17 GRP	101.00	8
				#40 GRP	114.00	
				#29 GRP	128.00	
	SILL	451TVG101	24'	#17 GRP	284.00	4
				#40 GRP	310.00	
				#29 GRP	342.00	
	JAMB	451TVG101	24'	#17 GRP	284.00	4
				#40 GRP	310.00	
				#29 GRP	342.00	
	MULLION	451SSG005	24'	#17 GRP	306.00	3
				#40 GRP	320.00	
				#29 GRP	358.00	
	WEATHERSEAL – 16 FOOT LONG PIECE (COLOR IS BLACK ONLY, DO NOT SPECIFY FINISH WHEN ORDERING)	451SSG250	16'	—	45.00	1

Laws and building and safety codes governing the design and use of glazed entrance, window, and curtain wall products vary widely. Kawneer does not control the selection of product configurations, operating hardware, or glazing materials, and assumes no responsibility therefor.

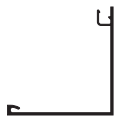
Kawneer reserves the right to change configuration without prior notice when deemed necessary for product improvement.

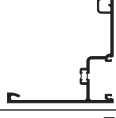
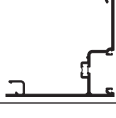
© Kawneer Company, Inc., 2008

DESCRIPTION	PART NO.	FT./UNIT	FINISH	PRICE/UNIT	UNITS/PKG.
CORNERS – FRONT SET I.G. (INSIDE GLAZE)					
 <p>NO POCKET CORNER HALF</p>	450017	24'	#17 GRP	\$227.00	4
			#40 GRP	244.00	
			#29 GRP	270.00	
 <p>FRONT/BACK FEMALE MULLION HALF</p>	451TVG010	24'	#17 GRP	235.00	4
			#40 GRP	254.00	
			#29 GRP	280.00	
 <p>FRONT/BACK ONE POCKET CORNER HALF</p>	451TVG015	24'	#17 GRP	342.00	4
			#40 GRP	360.00	
			#29 GRP	404.00	
 <p>FRONT/BACK ONE POCKET CORNER HALF</p>	451TVG035	24'	#17 GRP	342.00	4
			#40 GRP	360.00	
			#29 GRP	404.00	
 <p>POCKET ZONE DAM (TWO [2] REQUIRED AT EACH GLASS POCKET AREA, ONE [1] AT HEAD AND ONE [1] AT SILL)</p>	127009	EACH	—	5.10	1

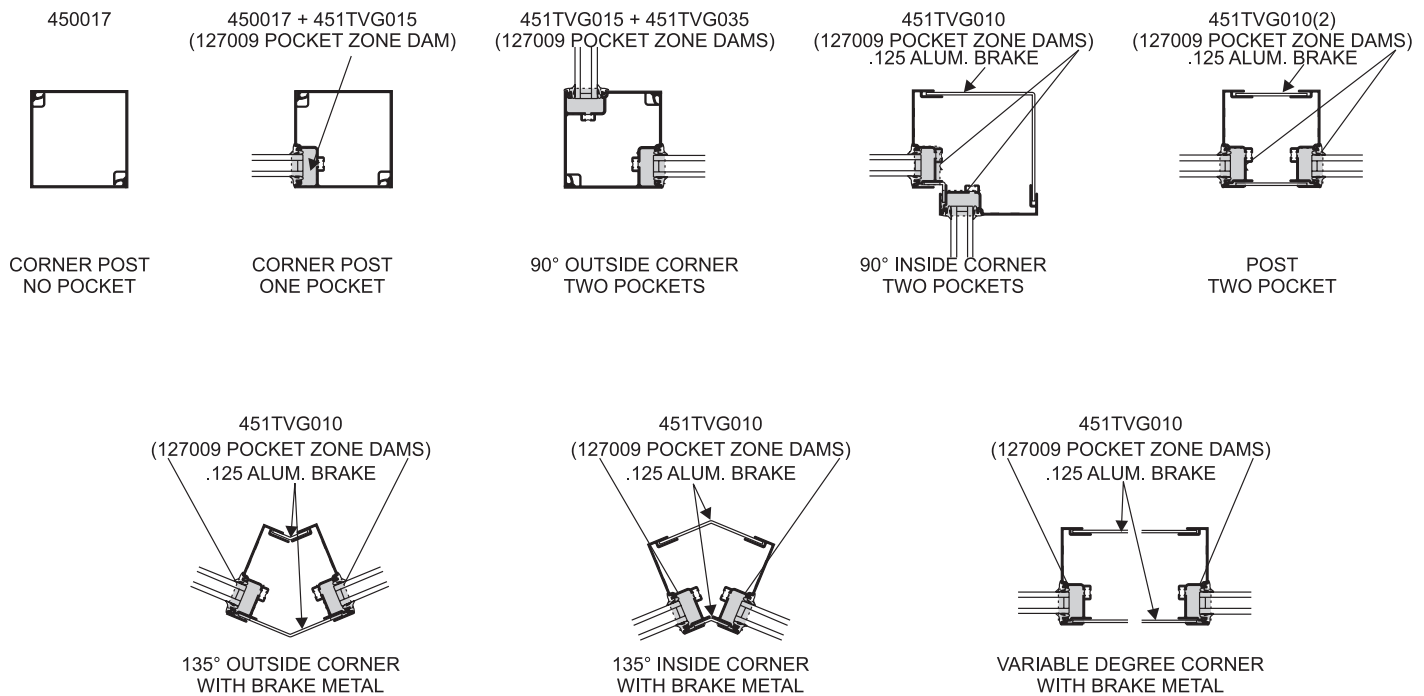









Laws and building and safety codes governing the design and use of glazed entrance, window, and curtain wall products vary widely. Kawneer does not control the selection of product configurations, operating hardware, or glazing materials, and assumes no responsibility therefor.

Kawneer reserves the right to change configuration without prior notice when deemed necessary for product improvement.
© Kawneer Company, Inc., 2008

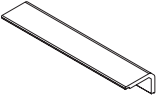
EC-97912-02



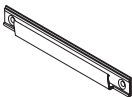

RECEPTORS / POCKET FILLERS / ADAPTORS

DESCRIPTION	PART NO.	FT./UNIT	FINISH	PRICE/UNIT	UNITS/PKG.	
COMPENSATING RECEPTORS						
	ONE PIECE COMPENSATING RECEPTOR W/WEATHERING (500 LB. MAX. END REACTION) (1000 LB. MAX. END REACTION WITH 2 EACH 451VG374 CLIPS AT EACH VERTICAL MULLION)	451TVG571	24'	#17 GRP	\$362.00	4
				#40 GRP	385.00	
				#29 GRP	428.00	
	COMPENSATING RECEPTOR REINFORCING CLIP	451VG374	EACH	—	9.00	1
	TWO PIECE COMPENSATING RECEPTOR W/WEATHERING (500 LB. MAX. END REACTION WITH 451VG572 FACE) (1000 LB. MAX. END REACTION WITH 451VG573 FACE AND 1 EACH 451VG374 CLIPS AT EACH VERTICAL MULLION)	451TVG570	24'	#17 GRP	282.00	4
				#40 GRP	302.00	
				#29 GRP	335.00	
	STANDARD COMPENSATING RECEPTOR FACE WITH WEATHERING	451VG572	24'	#17 GRP	120.00	4
				#40 GRP	128.00	
				#29 GRP	140.00	
	HEAVYWEIGHT COMPENSATING RECEPTOR FACE WITH WEATHERING	451VG573	24'	#17 GRP	140.00	4
				#40 GRP	148.00	
				#29 GRP	165.00	
	COMPENSATING RECEPTOR REINFORCING CLIP	451VG374	EACH	—	9.00	1
ADAPTORS						
	SNAP-IN POCKET FILLER	451087	24'	#17 GRP	34.00	8
				#40 GRP	38.00	
				#29 GRP	42.00	
	VENT ADAPTOR	469407	12'	#00	45.00	8
BRAKE METAL ADAPTORS						
	BRAKE METAL ADAPTOR (HORIZONTAL OR VERTICAL) (SNAP-IN OR SCREW APPLIED)	451TVG150	24'	#17 CLEAR	184.00	8
	STOOL TRIM CLIP PACKAGE (INCLUDES FASTENERS)	069271	EACH	—	2.00	1

Laws and building and safety codes governing the design and use of glazed entrance, window, and curtain wall products vary widely. Kawneer does not control the selection of product configurations, operating hardware, or glazing materials, and assumes no responsibility therefor.

Kawneer reserves the right to change configuration without prior notice when deemed necessary for product improvement.

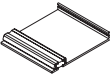
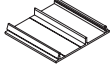



© Kawneer Company, Inc., 2008

DESCRIPTION	PART NO.	FT./UNIT	FINISH	PRICE/UNIT	UNITS/PKG.
FASTENERS					
 SPLINE SCREW (TYPE AB PAN HEAD #12 X 1 1/8" ZINC PLATED STEEL)	028856	EACH	—	\$ 0.11	100
 OPTIONAL SPLINE SCREW (TYPE HEXAGON SOCKET HEAD - THREAD FORMING #12-14 X 1" ZINC PLATED STEEL)	128242	EACH	—	1.20	100
 BALL POINT BIT FOR USE WITH 128242 OPTIONAL SPLINE SCREW	063040	EACH	—	20.00	1
 SHEAR BLOCK SCREW (TYPE B PAN HEAD #10 X 1 1/2" STAINLESS STEEL)	028400	EACH	—	0.18	100
 SHEAR BLOCK SCREW (TYPE B FLAT HEAD #10 X 3/8" STAINLESS STEEL)	128345	EACH	—	0.15	100
DRILL FIXTURES					
 DRILL FIXTURE - PUNCHED OPENING SYSTEM	451VG202	EACH	—	110.00	1
SHIM BACKER					
 SHIM BACKER (3" LONG PIECE) (USED AT HEAD)	451T126	EACH	—	3.50	1
 SHIM BACKER (3" LONG PIECE) (USED AT SILL AND JAMB)	451VG126	EACH	—	2.00	1
OPTIONAL HEAD ANCHOR					
 OPTIONAL HEAD ANCHOR	451VG327	EACH	—	4.75	1
GLAZING ACCESSORIES					
 WATER DEFLECTOR	451105	EACH	—	0.60	1
 WATER DEFLECTOR	451SSG105	EACH	—	2.05	1
 END DAM - USED AT HEAD/SILL	451VG314	EACH	—	2.70	1
 POCKET ZONE DAM (TWO [2] REQUIRED AT EACH GLASS POCKET AREA, ONE [1] AT HEAD AND ONE [1] AT SILL)	127009	EACH	—	5.10	1

Laws and building and safety codes governing the design and use of glazed entrance, window, and curtain wall products vary widely. Kawneer does not control the selection of product configurations, operating hardware, or glazing materials, and assumes no responsibility therefor.

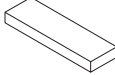
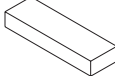
Kawneer reserves the right to change configuration without prior notice when deemed necessary for product improvement.











© Kawneer Company, Inc., 2008

DESCRIPTION			PART NO.	FT./UNIT	FINISH	PRICE/UNIT	UNITS/PKG.
GLAZING ACCESSORIES							
	SETTING BLOCK (1 1/4" X 3/16")	EPDM	027081	EACH	—	\$0.52	1
		SILICONE	027081-SI	EACH	—	2.60	1
	SETTING BLOCK (1 1/4" X 3/16")	EPDM	027073	EACH	—	1.15	1
		SILICONE	027073-SI	EACH	—	5.75	1
	SETTING BLOCK CHAIR – FOR USE AT SILL		451VG325	EACH	—	2.00	1
	"W" SIDE BLOCK		480520	EACH	—	1.20	1
	"W" SIDE BLOCK – USED AT JAMB		123392	EACH	—	1.25	1
	TEMPORARY GLAZING CLIP		250218	EACH	—	1.80	—

Laws and building and safety codes governing the design and use of glazed entrance, window, and curtain wall products vary widely. Kawneer does not control the selection of product configurations, operating hardware, or glazing materials, and assumes no responsibility therefor.

Kawneer reserves the right to change configuration without prior notice when deemed necessary for product improvement.

© Kawneer Company, Inc., 2008

DESCRIPTION	PART NO.	FT./UNIT	FINISH	PRICE/UNIT	UNITS/PKG.	
GLAZING ADAPTORS – CAPTURED						
	SNAP-IN INFILL ADAPTOR (FOR 1/4" INFILL)	451VG029	24'	#17 CLEAR	\$ 32.00	8
				#40 BRONZE	35.00	
				#29 BLACK	37.00	
	SNAP-IN INFILL ADAPTOR (FOR 3/8" INFILL)	451VG030	24'	#17 CLEAR	24.00	8
				#40 BRONZE	28.00	
				#29 BLACK	32.00	
GLAZING ADAPTORS – SSG/WEATHERSEAL						
	FULL WIDTH INFILL ADAPTOR (FOR 1/4" INFILL)	451SSG029	24'	#17 CLEAR	114.00	8
				#40 BRONZE	125.00	
				#29 BLACK	140.00	
	HALF WIDTH INFILL ADAPTOR (FOR 1/4" INFILL)	451SSG029A	24'	#17 CLEAR	53.00	8
				#40 BRONZE	58.00	
				#29 BLACK	63.00	
WEATHERSEAL						
	WEATHERSEAL – 16 FOOT LONG PIECE (COLOR IS BLACK ONLY, DO NOT SPECIFY FINISH WHEN ORDERING)	451SSG250	24'	—	45.00	1
	1/4" SPANDREL WEATHERSEAL – 16 FOOT LONG PIECE (COLOR IS BLACK ONLY, DO NOT SPECIFY FINISH WHEN ORDERING) (REQUIRES 451SSG029 ADAPTOR)	450SSG250	24'	—	40.00	1
SSG SPACERS						
	SSG WEDGE SPACER	127008	FOOT	—	1.64 (\$410.00/ROLL)	250' ROLL
GASKETS						
	STANDARD PUSH ON GASKET	027074	FOOT	—	0.46 (\$230.00/ROLL)	500' ROLL
	LIGHT PUSH ON GASKET	027076	FOOT	—	0.41 (\$208.00/ROLL)	500' ROLL
	HEAVY PUSH ON GASKET	027077	FOOT	—	0.54 (\$272.00/ROLL)	500' ROLL

GLAZING CHARTS**GLAZING CHART – TRIFAB® VG 451T (CAPTURED)**

Infill Thickness	Adaptor	Weathering (Both Sides)
1/8"	451VG029	027077 Heavy
1/4"	451VG029	027074 Std.
3/8"	451VG029	027076 Light
1/2"	451VG030	027077 Heavy
5/8"	451VG030	027074 Std.
3/4"	451VG030	027076 Light
7/8"	—	027077 Heavy
1"	—	027074 Std.
1 1/8"	—	027076 Light

NOTE: FOR INFILL THICKNESS IN 1/16" INCREMENTS OR OVERSIZE AND UNDERSIZE GLASS, USE A COMBINATION OF THE STD. (027074) WITH EITHER THE LIGHT (027076) OR HEAVY (027077) GASKETS.

GLAZING CHART – TRIFAB® VG 451T (SSG/W-SEAL)

Infill Thickness	Adaptor	Interior	Exterior
Jambs/Head/Sill/Horizontal			
1/4"	451SSG029	027074 Std.	027074 Std.
1"	—	027074 Std.	027074 Std.
SSG Mullion			
1/4"	451SSG029	127008 Spacer	—
1"	—	127008 Spacer	—
Weatherseal Mullion			
1/4"	451SSG029	127008 Spacer	450SSG250 W-seal
1"	—	127008 Spacer	451SSG250 W-seal

Laws and building and safety codes governing the design and use of glazed entrance, window, and curtain wall products vary widely. Kawneer does not control the selection of product configurations, operating hardware, or glazing materials, and assumes no responsibility therefor.

Kawneer reserves the right to change configuration without prior notice when deemed necessary for product improvement.

© Kawneer Company, Inc., 2008